

GEMÜ 639 eSyStep Positioner (Code S0)

Motorized diaphragm valve

EN **Operating instructions**



All rights including copyrights or industrial property rights are expressly reserved.

Keep the document for future reference.

© GEMÜ Gebr. Müller Apparatebau GmbH & Co. KG
17.06.2024

Contents

1	General information	4	22	EU Declaration of Conformity In accordance with 2011/65/EU (RoHS Directive)	75
1.1	Information	4			
1.2	Symbols used	4			
1.3	LED symbols	4			
1.4	Definition of terms	4			
1.5	Warning notes	4			
2	Safety information	5			
3	Product description	5			
3.1	Construction	5			
3.2	LED displays	6			
3.3	Description	6			
3.4	Function	7			
4	GEMÜ CONEXO	7			
5	Correct use	7			
6	Order data	8			
7	Technical data	11			
8	Electrical connection	17			
9	Dimensions	22			
10	Manufacturer's information	36			
10.1	Delivery	36			
10.2	Packaging	36			
10.3	Transport	36			
10.4	Storage	36			
11	Installation in piping	36			
11.1	Preparing for installation	36			
11.2	Installation position	36			
11.3	Installation with clamp connections	37			
11.4	Installation with butt weld spigots	37			
11.5	Installation with threaded sockets	37			
11.6	Installation with threaded spigots	37			
12	Specific data IO-Link (pin 6)	38			
12.1	Operation on IO-Link	38			
12.2	Process data	41			
12.3	Parameter overview	42			
12.4	Parameter	46			
12.5	Events	63			
13	Operation	65			
13.1	Initialization	65			
13.2	Manual override	65			
14	Inspection and maintenance	66			
14.2	Removing the actuator	66			
14.3	Removing the diaphragm	66			
14.6	Mounting the actuator	68			
15	Troubleshooting	69			
16	Removal from piping	71			
17	Disposal	71			
18	Returns	71			
19	EU Declaration of Incorporation according to the EC Machinery Directive 2006/42/EC, Annex II B ...	72			
20	EU Declaration of Conformity in accordance with 2014/68/EU (Pressure Equipment Directive)	73			
21	EU Declaration of Conformity in accordance with 2014/30/EU (EMC Directive)	74			

1 General information

1.1 Information

- The descriptions and instructions apply to the standard versions. For special versions not described in this document the basic information contained herein applies in combination with any additional special documentation.
- Correct installation, operation, maintenance and repair work ensure faultless operation of the product.
- Should there be any doubts or misunderstandings, the German version is the authoritative document.
- Contact us at the address on the last page for staff training information.

1.2 Symbols used

The following symbols are used in this document:

Symbol	Meaning
●	Tasks to be performed
▶	Response(s) to tasks
-	Lists

1.3 LED symbols

The following LED symbols are used in the documentation:

Symbol	LED conditions
○	Off
●	Lit (on)
☼	Flashing

1.4 Definition of terms

Working medium

The medium that flows through the GEMÜ product.

Diaphragm size

Uniform seat size of GEMÜ diaphragm valves for different nominal sizes.



1.5 Warning notes



Wherever possible, warning notes are organised according to the following scheme:



SIGNAL WORD	
Possible symbol for the specific danger	<p>Type and source of the danger</p> <ul style="list-style-type: none"> ▶ Possible consequences of non-observance. ● Measures for avoiding danger.

Warning notes are always marked with a signal word and sometimes also with a symbol for the specific danger.

The following signal words and danger levels are used:





 DANGER	
	<p>Imminent danger!</p> <ul style="list-style-type: none"> ▶ Non-observance can cause death or severe injury.

 WARNING	
	<p>Potentially dangerous situation!</p> <ul style="list-style-type: none"> ▶ Non-observance can cause death or severe injury.

 CAUTION	
	<p>Potentially dangerous situation!</p> <ul style="list-style-type: none"> ▶ Non-observance can cause moderate to light injury.

NOTICE	
	<p>Potentially dangerous situation!</p> <ul style="list-style-type: none"> ▶ Non-observance can cause damage to property.

The following symbols for the specific dangers can be used within a warning note:

Symbol	Meaning
	Danger of explosion!
	The equipment is subject to pressure!
	Corrosive chemicals!
	Hot plant components!
	Maximum permissible pressure exceeded.

2 Safety information

The safety information in this document refers only to an individual product. Potentially dangerous conditions can arise in combination with other plant components, which need to be considered on the basis of a risk analysis. The operator is responsible for the production of the risk analysis and for compliance with the resulting precautionary measures and regional safety regulations.

The document contains fundamental safety information that must be observed during commissioning, operation and maintenance. Non-compliance with these instructions may cause:

- Personal hazard due to electrical, mechanical and chemical effects.
- Hazard to nearby equipment.
- Failure of important functions.
- Hazard to the environment due to the leakage of dangerous substances.

The safety information does not take into account:

- Unexpected incidents and events, which may occur during installation, operation and maintenance.
- Local safety regulations which must be adhered to by the operator and by any additional installation personnel.

Prior to commissioning:

1. Transport and store the product correctly.
2. Do not paint the bolts and plastic parts of the product.
3. Carry out installation and commissioning using trained personnel.
4. Provide adequate training for installation and operating personnel.
5. Ensure that the contents of the document have been fully understood by the responsible personnel.
6. Define the areas of responsibility.
7. Observe the safety data sheets.
8. Observe the safety regulations for the media used.

During operation:

9. Keep this document available at the place of use.
10. Observe the safety information.
11. Operate the product in accordance with this document.
12. Operate the product in accordance with the specifications.
13. Maintain the product correctly.
14. Do not carry out any maintenance work and repairs not described in this document without consulting the manufacturer first.

In cases of uncertainty:

15. Consult the nearest GEMÜ sales office.

3 Product description

3.1 Construction

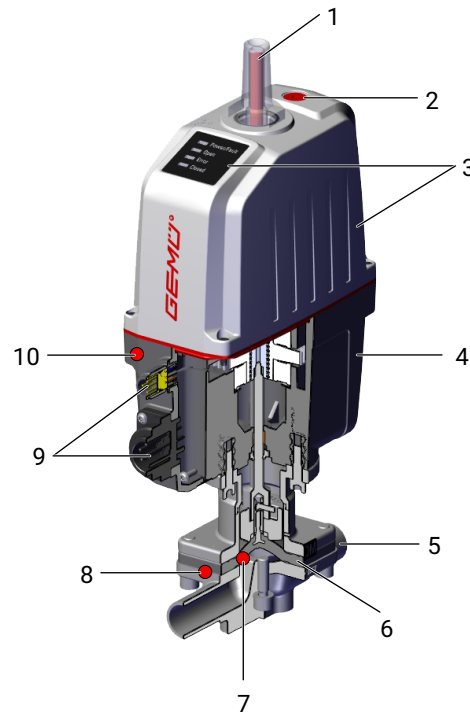

Item	Name	Materials
1	Optical position indicator	PA 12
2	Manual override	
3	Actuator top with LED display	Reinforced polyamide
4	Actuator base	Reinforced polyamide
5	Valve body	EN-GJS-400-18-LT (GGG 40.3) EN-GJS-400-18-LT (GGG 40.3), PFA lined EN-GJS-400-18-LT (GGG 40.3), PP lined EN-GJS-400-18-LT (GGG 40.3), hard rubber lined 1.4408, investment casting 1.4408, PFA lined 1.4435 (F316L), forged body 1.4435 (BN2), forged body, Δ Fe < 0.5 % 1.4435, investment casting 1.4539, forged body CW614N, CW617N (brass)
6	Diaphragm	CR, EPDM, FKM, NBR, PTFE/EPDM (one-piece), PTFE/EPDM (two-piece)
7	CONEXO diaphragm RFID chip (see Conexo information)	

Item	Name	Materials
8	CONEXO body RFID chip (see Conexo information)	
9	Electrical connections	
10	CONEXO actuator RFID chip (see Conexo information)	

3.2 LED displays

3.2.1 Status LEDs

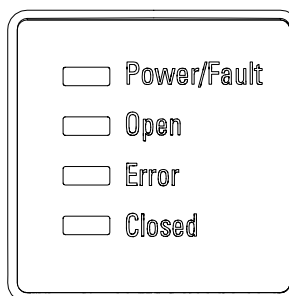

LED	Colour		Function
	Standard	Inversed ¹⁾	
Power/fault	green	green	Operating indication/ communication status
	red	red	
Open	orange	green	Process valve in OPEN position
Error	red	red	Error
Closed	green	orange	Process valve in CLOSED position

1) Inversed representation of the OPEN and CLOSED LEDs, adjustable via IO-Link

3.2.2 LED conditions

Status process valve	Power/fault	Open	Error	Closed
OPEN position	●	●	○	○
CLOSED position	●	○	○	●
Position unknown	●	○	○	○
IO-Link communication	☀	○	○	○
Initialization	●	☀	○	☀
		Open and Closed flash alternately		

LED conditions					
●	lit (on)	☀	flashes	○	off

3.3 Description

The GEMÜ 639 eSyStep 2/2-way diaphragm valve is electrically operated. The eSyStep actuator is available as an On/Off actuator or with an integrated positioner. An optical and electrical position indicator is integrated as standard. The self-locking actuator holds its position in a stable manner when idle and in the event of a power supply failure.

3.4 Function

The product controls or regulates (depending on version) a flowing medium by being closed or opened by a motorized actuator.

The product is equipped as standard with a mechanical position indicator as well as an electrical position and status indicator.

4 GEMÜ CONEXO

Order without CONEXO

If you have ordered the product without CONEXO functionality, the RFID chip is used for traceability in the production process and quality assurance. Expansion to include the CONEXO functionality at a later date must be coordinated with GEMÜ.

Order with CONEXO

GEMÜ CONEXO must be ordered separately with the ordering option "CONEXO" (see order data).

For electronic identification purposes, each replaceable component contained in the product is equipped with an RFID chip (1). Where you can find the RFID chip differs from product to product.

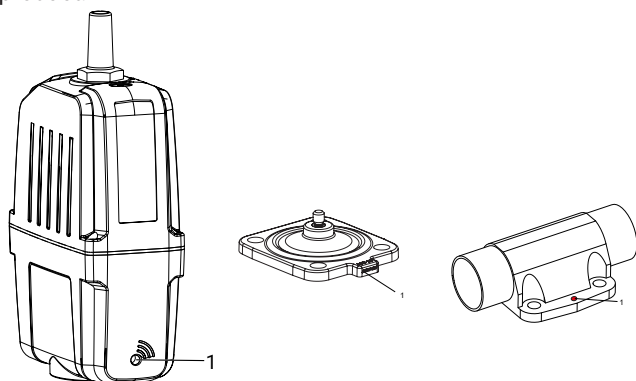

Actuator RFID chip

Diaphragm RFID chip

Valve body RFID chip

The CONEXO pen helps read out information stored in these RFID chips. The CONEXO app or CONEXO portal is required to view this information.

5 Correct use

 DANGER	
	<p>Danger of explosion!</p> <ul style="list-style-type: none"> ▶ Risk of death or severe injury ● Do not use the product in potentially explosive zones.

WARNING

Improper use of the product!

- ▶ Risk of severe injury or death
- ▶ Manufacturer liability and guarantee will be void.
- Only use the product in accordance with the operating conditions specified in the contract documentation and in this document.

The product is designed for installation in piping systems and for controlling a working medium.

The product is not intended for use in potentially explosive areas.

- Use the product in accordance with the technical data.

6 Order data

The order data provide an overview of standard configurations.

Please check the availability before ordering. Other configurations available on request.

Order codes

1 Type	Code
Diaphragm valve, electrically operated, eSyStep	639

2 DN	Code
DN 4	4
DN 6	6
DN 8	8
DN 10	10
DN 12	12
DN 15	15
DN 20	20
DN 25	25
DN 32	32
DN 40	40

3 Body configuration	Code
Tank bottom valve body	B
Body configuration code B: Dimensions and designs on request	
2/2-way body	D
T-body	T
Body configuration code T: For dimensions, see T Valves brochure	

4 Connection type	Code
Spigot	
Spigot DIN	0
Spigot DIN EN 10357 series B (2014 edition; formerly DIN 11850 series 1)	16
Spigot EN 10357 series A/DIN 11866 series A formerly DIN 11850 series 2	17
Spigot DIN 11850 series 3	18
Spigot JIS-G 3447	35
Spigot JIS-G 3459 schedule 10s	36
Spigot SMS 3008	37
Spigot BS 4825, part 1	55
Spigot ASME BPE/DIN EN 10357 series C (from 2022 edition)/DIN 11866 series C	59
Spigot ISO 1127/DIN EN 10357 series C (2014 edition)/DIN 11866 series B	60
Spigot ANSI/ASME B36.19M schedule 10s	63
Spigot ANSI/ASME B36.19M schedule 5s	64
Spigot ANSI/ASME B36.19M schedule 40s	65
Threaded connection	
Threaded socket DIN ISO 228	1
NPT female thread	31
Threaded spigot DIN 11851	6
Cone spigot and union nut DIN 11851	6K

4 Connection type	Code
Flange	
Flange EN 1092, PN 16, form B, face-to-face dimension FTF EN 558 series 1, ISO 5752, basic series 1, length only for body configuration D	8
Flange JIS B2220, 10K, RF, face-to-face dimension FTF EN 558 series 1, ISO 5752, basic series 1, length only for body configuration D	34
Flange ANSI Class 150 RF, face-to-face dimension FTF MSS SP-88, length only for body configuration D	38
Flange ANSI Class 125/150 RF, face-to-face dimension FTF EN 558 series 1, ISO 5752, basic series 1, length only for body configuration D	39
Clamp	
Clamp ASME BPE, face-to-face dimension FTF ASME BPE, length only for body configuration D	80
Clamp DIN 32676 series B, face-to-face dimension FTF EN 558 series 7, length only for body configuration D	82
Clamp ASME BPE, for pipe ASME BPE, face-to-face dimension FTF EN 558 series 7, length only for body configuration D	88
Clamp DIN 32676 series A, face-to-face dimension FTF acc. to EN 558 series 7, length only for body configuration D	8A
Clamp ISO 2852 for pipe ISO 2037, clamp SMS 3017 for pipe SMS 3008 face-to-face dimension FTF EN 558 series 7, length only for body configuration D	8E
Clamp DIN 32676 series C, face-to-face dimension FTF ASME BPE, length only for body configuration D	8P
Clamp DIN 32676 series C, face-to-face dimension FTF EN 558 series 7, length only for body configuration D	8T

5 Valve body material	Code
SG iron material	
EN-GJS-400-18-LT (GGG 40.3), PFA lined	17
EN-GJS-400-18-LT (GGG 40.3), PP lined	18
EN-GJS-400-18-LT (GGG 40.3), hard rubber lined	83
EN-GJS-400-18-LT (GGG 40.3)	90
Investment casting material	
1.4408, investment casting	37
1.4408, PFA lined	39

5 Valve body material	Code
1.4435, investment casting	C3
Forged material	
1.4435 (F316L), forged body	40
1.4435 (BN2), forged body, Δ Fe < 0.5%	42
1.4539, forged body	F4
Brass	
CW614N, CW617N (brass)	12

6 Diaphragm material	Code
Elastomer	
NBR	2
EPDM	3A
FKM	4
FKM	4A
CR	8
EPDM	13
EPDM	17
EPDM	19
EPDM	28
EPDM	29
PTFE	
PTFE/EPDM one-piece	54
PTFE/EPDM two-piece	5M
Note: The PTFE/EPDM diaphragm (code 5M) is available from diaphragm size 25.	

7 Voltage/Frequency	Code
24 V DC	C1

8 Control module	Code
Positioner	S0
Positioner, configured for emergency power supply module (NC)	S5
Positioner, configured for emergency power supply module (NO)	S6

9 Surface	Code
$Ra \leq 6.3 \mu\text{m}$ (250 $\mu\text{in.}$) for media wetted surfaces, mechanically polished internal	1500
$Ra \leq 0.8 \mu\text{m}$ (30 $\mu\text{in.}$) for media wetted surfaces, in accordance with DIN 11866 H3, mechanically polished internal	1502
$Ra \leq 0.8 \mu\text{m}$ (30 $\mu\text{in.}$) for media wetted surfaces, in accordance with DIN 11866 HE3, electropolished internal/external	1503
$Ra \leq 0.6 \mu\text{m}$ (25 $\mu\text{in.}$) for media wetted surfaces, mechanically polished internal	1507
$Ra \leq 0.6 \mu\text{m}$ (25 $\mu\text{in.}$) for media wetted surfaces, electropolished internal/external	1508
$Ra \leq 0.4 \mu\text{m}$ (15 $\mu\text{in.}$) for media wetted surfaces, in accordance with DIN 11866 H4, mechanically polished internal	1536
$Ra \leq 0.4 \mu\text{m}$ (15 $\mu\text{in.}$) for media wetted surfaces, in accordance with DIN 11866 HE4, electropolished internal/external	1537

9 Surface	Code
$Ra \leq 0.25 \mu\text{m}$ (10 $\mu\text{in.}$) for media wetted surfaces *), in accordance with DIN 11866 HE5, electropolished internal/external, *) for inner pipe diameters < 6 mm, in the spigot $Ra \leq 0.38 \mu\text{m}$	1516
$Ra \leq 0.25 \mu\text{m}$ (10 $\mu\text{in.}$) for media wetted surfaces *), in accordance with DIN 11866 H5, mechanically polished internal, *) for inner pipe diameters < 6 mm, in the spigot $Ra \leq 0.38 \mu\text{m}$	1527
Ra max. $0.51 \mu\text{m}$ (20 $\mu\text{in.}$) for media wetted surfaces, in accordance with ASME BPE SF1, mechanically polished internal	SF1
Ra max. $0.64 \mu\text{m}$ (25 $\mu\text{in.}$) for media wetted surfaces, in accordance with ASME BPE SF2, mechanically polished internal	SF2
Ra max. $0.76 \mu\text{m}$ (30 $\mu\text{in.}$) for media wetted surfaces, in accordance with ASME BPE SF3, mechanically polished internal	SF3
Ra max. $0.38 \mu\text{m}$ (15 $\mu\text{in.}$) for media wetted surfaces, in accordance with ASME BPE SF4, electropolished internal/external	SF4
Ra max. $0.51 \mu\text{m}$ (20 $\mu\text{in.}$) for media wetted surfaces, in accordance with ASME BPE SF5, electropolished internal/external	SF5
Ra max. $0.64 \mu\text{m}$ (25 $\mu\text{in.}$) for media wetted surfaces, in accordance with ASME BPE SF6, electropolished internal/external	SF6

10 Actuator version	Code
DN 4 - 15, diaphragm size 8	
Actuator size 0 diaphragm size 8	0B
DN 10–20, diaphragm size 10	
Actuator size 0	0A
DN 15 - 25, diaphragm size 25	
Actuator size 1	1A
DN 32 - 40, diaphragm size 40	
Actuator size 1	1A

11 Special version	Code
Without	
BELGAQUA certification	B
Special version for oxygen, maximum medium temperature: 60 °C	S

12 CONEXO	Code
Without	
Integrated RFID chip for electronic identification and traceability	C

Order example

Ordering option	Code	Description
1 Type	639	Diaphragm valve, electrically operated, eSyStep
2 DN	15	DN 15
3 Body configuration	D	2/2-way body
4 Connection type	60	Spigot ISO 1127/DIN EN 10357 series C (2014 edition)/DIN 11866 series B
5 Valve body material	40	1.4435 (F316L), forged body
6 Diaphragm material	54	PTFE/EPDM one-piece
7 Voltage/Frequency	C1	24 V DC
8 Control module	S0	Positioner
9 Surface	1503	Ra ≤ 0.8 µm (30 µin.) for media wetted surfaces, in accordance with DIN 11866 HE3, electropolished internal/external
10 Actuator version	0A	Actuator size 0
11 Special version		Without
12 CONEXO	C	Integrated RFID chip for electronic identification and traceability

7 Technical data

7.1 Medium

Working medium: Corrosive, inert, gaseous and liquid media which have no negative impact on the physical and chemical properties of the body and diaphragm material.

For special oxygen version (code S): only gaseous oxygen

7.2 Temperature

Media temperature:

Diaphragm material	Standard	Special version for oxygen
NBR (code 2)	-10 – 100 °C	-
FKM (code 4)	-10 – 90 °C	-
CR (code 8)	-10 – 100 °C	-
EPDM (code 13)	-10 – 100 °C	0 – 60 °C
EPDM (code 17)	-10 – 100 °C	-
EPDM (code 19)	-10 – 100 °C	0 – 60 °C
EPDM (code 28)	-10 – 85 °C	-
EPDM (code 29)	-10 – 100 °C	-
PTFE/EPDM (code 54)	-10 – 100 °C	0 – 60 °C
PTFE/EPDM (code 5M)	-10 – 100 °C	0 – 60 °C

Sterilization temperature:

EPDM (code 13)	max. 150 °C, max. 60 min per cycle
EPDM (code 17)	max. 150 °C, max. 180 min per cycle
EPDM (code 19)	max. 150 °C, max. 180 min per cycle
PTFE/EPDM (code 54)	max. 150 °C, constant temperature per cycle
PTFE/EPDM (code 5M)	max. 150 °C, constant temperature per cycle

The sterilization temperature is only valid for steam (saturated steam) or superheated water.

If the sterilization temperatures listed above are applied to the EPDM diaphragms for longer periods of time, the service life of the diaphragms will be reduced. In these cases, maintenance cycles must be adapted accordingly.

PTFE diaphragms can also be used as steam barriers; however, this will reduce their service life. This also applies to PTFE diaphragms exposed to high temperature fluctuations. The maintenance cycles must be adapted accordingly. GEMÜ 555 and 505 globe valves are particularly suitable for use in the area of steam generation and distribution. The following valve arrangement for interfaces between steam pipes and process pipes has proven itself over time: A globe valve for shutting off steam pipes and a diaphragm valve as an interface to the process pipes.

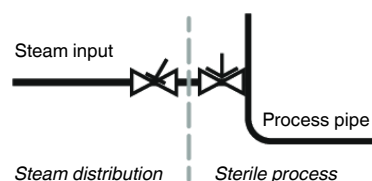

Ambient temperature: 0 – 60 °C

Storage temperature: 0 – 40 °C

7.3 Pressure

Operating pressure:

MG	DN	Actuator version	Diaphragm material		
			Elastomer	PTFE	
				Forged material	Cast material with and without lining
8	4 - 15	0B	0 - 10	0 - 10	0 - 6
10	10 - 20	0A	0 - 10	0 - 10	0 - 6
25	15 - 25	1A	0 - 8	0 - 8	0 - 6
40	32 - 40	1A	0 - 8	0 - 4	0 - 4

MG = diaphragm size

All pressures are gauge pressures. Operating pressure values were determined with static operating pressure applied on one side of a closed valve. Sealing at the valve seat and atmospheric sealing is ensured for the given values.

Information on operating pressures applied on both sides and for high purity media on request.

Pressure rating:

PN 16

Leakage rate:

Leakage rate A to P11/P12 EN 12266-1

Cv values:

MG	DN	Connection type code								
		0	16	17	18	37	59	60	1	31
8	4	0.5	-	-	-	-	-	-	-	-
	6	-	-	1.1	-	-	-	1.2	-	-
	8	-	-	1.3	-	-	0.6	2.2	1.4	-
	10	-	2.1	2.1	2.1	-	1.3	-	-	-
	15	-	-	-	-	-	2.0	-	-	-
10	10	-	2.4	2.4	2.4	-	2.2	3.3	-	-
	12	-	-	-	-	-	-	-	3.2	-
	15	3.3	3.8	3.8	3.8	-	2.2	4.0	3.4	-
	20	-	-	-	-	-	3.8	-	-	-
25	15	4.1	4.7	4.7	4.7	-	-	7.4	6.5	6.5
	20	6.3	7.0	7.0	7.0	-	4.4	13.2	10.0	10.0
	25	13.9	15.0	15.0	15.0	12.6	12.2	16.2	14.0	14.0
40	32	25.3	27.0	27.0	27.0	26.2	-	30.0	26.0	26.0
	40	29.3	30.9	30.9	30.9	30.2	29.5	32.8	33.0	33.0

MG = diaphragm size, Kv values in m³/h

Kv values determined in accordance with DIN EN 60534 standard, inlet pressure 5 bar, Δp 1 bar, stainless steel valve body and soft elastomer diaphragm. The Kv values for other product configurations (e.g. other diaphragm or body materials) may differ. In general, all diaphragms are subject to the influences of pressure, temperature, the process and their tightening torques. Therefore the Kv values may exceed the tolerance limits of the standard.

The Kv value curve (Kv value dependent on valve stroke) can vary depending on the diaphragm material and duration of use.

Cv values:

MG	DN	Cast body without lining		Rubber lining	Plastic lining
		Threaded body	Flanged body		
		Material code 90		Material code 83	Material code 17, 18, 39
25	15	8.0	10.0	5.0	6.0
	20	11.5	14.0	9.0	11.0
	25	11.5	17.0	13.0	15.0
40	32	28.0	36.0	23.0	29.0
	40	28.0	40.0	26.0	32.0

MG = diaphragm size, Kv values in m³/h

Kv values determined in accordance with DIN EN 60534, inlet pressure 5 bar, Δp 1 bar, with connection flange EN 1092 length EN 558 series 1 (or threaded socket DIN ISO 228 for body material GGG40.3) and soft elastomer diaphragm. The Kv values for other product configurations (e.g. other diaphragm or body materials) may differ. In general, all diaphragms are subject to the influences of pressure, temperature, the process and their tightening torques. Therefore the Kv values may exceed the tolerance limits of the standard.

The Kv value curve (Kv value dependent on valve stroke) can vary depending on the diaphragm material and duration of use.

7.4 Product compliance

Machinery Directive: 2006/42/EC

Pressure Equipment Directive: 2014/68/EU

Food: Regulation (EC) No. 1935/2006
Regulation (EC) No. 10/2011*
FDA*
USP* Class VI

EMC Directive: 2014/30/EU

Drinking water: Belgaqua*
* depending on version and/or operating parameters

RoHS Directive: 2011/65/EU

7.5 Mechanical data**Protection class:** IP 65 acc. to EN 60529**Actuating speed:** Max. 3 mm/s**Weight:****Actuator**

Actuator size 0 (code 0A / 0B) 0.95 kg

Actuator size 1 (code 1A) 1.88 kg

Body

Connection type code		0, 16, 17, 18, 35, 36, 37, 55, 59, 60, 63, 64, 65	1	1	1, 31	31	6, 6K	8, 38, 39	80, 82, 88, 8A, 8E, 8P, 8T
Valve body		Spigot	Threaded socket				Threaded spigot	Flange	Clamp
Material code			12	37	90	37			
MG	DN								
8	4	0.09	-	-	-	-	-	-	-
	6	0.09	-	-	-	-	-	-	-
	8	0.09	-	0.09	-	-	-	-	0.15
	10	0.09	-	-	-	-	0.21	-	0.18
	15	0.09	-	-	-	-	-	-	0.18
10	10	0.30	-	-	-	-	0.33	-	0.30
	12	-	0.17	0.17	-	-	-	-	-
	15	0.30	0.26	0.26	-	-	0.35	-	0.43
	20	-	-	-	-	-	-	-	0.43
25	15	0.62	-	0.32	0.50	0.32	0.71	1.50	0.75
	20	0.58	-	0.34	0.60	0.34	0.78	2.20	0.71
	25	0.55	-	0.39	0.90	0.39	0.79	2.80	0.63
40	32	1.45	-	0.88	1.40	0.88	1.66	3.40	1.62
	40	1.32	-	0.93	1.90	0.93	1.62	4.50	1.50

MG = diaphragm size, weight in kg

Mechanical environmental conditions:

Class 4M8 acc. to EN 60721-3-4:1998

Vibration:

5g acc. to IEC 60068-2-6 Test Fc

Shock:

25g acc. to 60068-2-27 Test Ea

Installation position:

Optional

Observe the angle of rotation for optimized draining when it comes to installation. See separate document, "Angle of rotation technical information".

7.6 Actuator duty cycle and service life

Service life: **Control operation** - Class C according to EN 15714-2 (1,800,000 starts and 1200 starts per hour).
Open/Close duty - At least 500,000 switching cycles at room temperature and permissible duty cycle.

Duty cycle: Control module Positioner (code S0, S5, S6), Open/Close duty

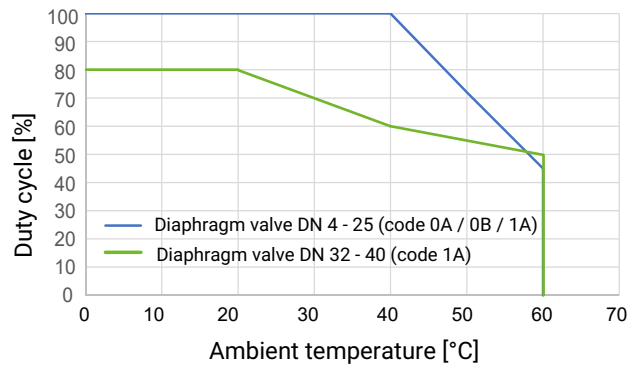

Control module positioner (code S0, S5, S6), control operation - class C acc. to EN 15714-2

- DN 4 - 25 (code 0A) up to 60 °C ambient temperature
- DN 32 - 40 (code 1A) up to 30 °C ambient temperature

NOTICE

- ▶ The specified characteristics and values apply to the default setting.
- ▶ With reduced forces, higher duty cycles and/or higher ambient temperatures are possible. At higher force settings the duty cycle and/or ambient temperature is reduced.
- ▶ IO-Link: Index 0x90 - Subindex 2 - Force

7.7 Electrical data

Supply voltage U_v:	24 V DC ± 10%	
Rating:	Actuator size 0 (code 0A, 0B)	20 W
	Actuator size 1 (code 1A)	60 W
Operation:	Stepper motor, self-locking	
Reverse battery protection:	Yes	

7.7.1 Analogue input signals – Control module Positioner (code S0, S5, S6)**7.7.1.1 Set value**

Input signal:	0/4 - 20 mA; 0 - 10 V (function selectable via IO-Link)	
Input type:	passive	
Input resistance:	250 Ω	
Accuracy/linearity:	≤ ±0.3% of full flow	
Temperature drift:	≤ ±0.1% / 10°K	
Resolution:	12 bit	
Reverse battery protection:	Yes (up to ± 24 V DC)	

7.7.2 Digital input signals

Inputs:	Function selectable via IO-Link (see table Overview of available functions – Input and output signals)	
Input voltage:	24 V DC	
Logic level "1":	> 15.3 V DC	
Logic level "0":	< 5.8 V DC	
Input current:	typically < 0.5 mA	

7.7.3 Analogue output signals – Control module Positioner (code S0, S5, S6)**7.7.3.1 Actual value**

Output signal:	0/4 - 20 mA; 0 - 10 V (function selectable via IO-Link)	
Output type:	Active	
Accuracy:	≤ ±1% of full flow	
Temperature drift:	≤ ±0.1% / 10°K	
Load resistor:	≤ 750 kΩ	
Resolution:	12 bit	
Short-circuit proof:	Yes	

7.7.4 Digital output signals

Outputs:	Function selectable via IO-Link (see table Overview of available functions – Input and output signals)
Type of contact:	Push-Pull
Switching voltage:	Power supply U_v
Switching current:	≤ 140 mA
Short-circuit proof:	Yes

7.7.5 Communication

Interface:	IO-Link
Function:	Parameterization/process data
Transmission rate:	38400 baud
Frame type in Operate:	2.V (eSyStep positioner, code S0, S5, S6), PDout 3Byte; PDin 3 Byte; OnRequestData 2 Byte
Min. cycle time:	20 ms (eSyStep positioner, code S0, S5, S6)
Vendor-ID:	401
Device-ID:	1906801 (eSyStep positioner, code S0, S5, S6),
Product-ID:	eSyStep Positioner (code S0, S5, S6)
ISDU support:	Yes
SIO operation:	Yes
IO-Link specification:	V1.1

IODD files can be downloaded via <https://ioddfinder.io-link.com/> or www.gemu-group.com.

7.8 Behaviour in the event of an error

Function:	In the event of an error the valve moves to the error position. Notes: Moving to the error position is only possible with full power supply. This behaviour is not a safety position. The valve must be operated with a GEMÜ 1571 emergency power supply module (see accessories) to ensure the function in case of voltage loss.
Error position:	Closed, open or hold (adjustable via IO-Link).

8 Electrical connection

NOTICE

Appropriate cable socket/appropriate mating connector

- The appropriate connectors are included for X1 and X2.

8.1 Position of the connectors

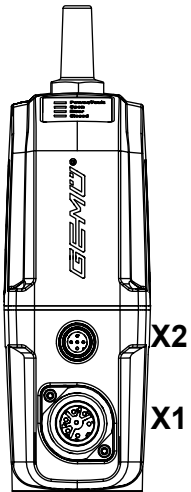

8.2 Electrical connection

8.2.1 Connection X1

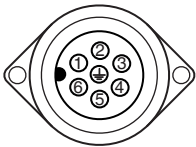

7-pin plug, Binder, type 693

Pin	Signal name
1	Uv, 24 V DC supply voltage
2	GND
3	Digital input 1
4	Digital input 2
5	Digital input/output
6	Digital output, IO-Link
7	n.c.

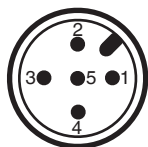
8.2.2 Connection X2 (only for positioner design)

5-pin M12 plug, A-coded

Pin	Signal name
1	I+/U+, set value input
2	I-/U-, set value input
3	I+/U+, actual value output
4	I-/U-, actual value output
5	n.c.

8.3 Overview of available functions – Input and output signals**NOTICE**

- ▶ The factory default setting "Configured for emergency power supply module" is reset to default settings when a reset is carried out.

NOTICE

- ▶ When the digital inputs for OPEN and CLOSE are activated simultaneously, the defined error position is approached.

	Function	Control module S0	Control module S5, S6
		Default settings	Factory default setting "Configured for emergency power supply module"
Digital input 1	Off/Open/Closed/Safe/On/Initialization	Initialization	Initialization
Digital input 2	Off/Open/Closed/Safe/On/Initialization	Off	Safe/On
Digital input/output	Open/Closed/Error/Error and warning/Initialization	Error	Error
Digital output	Open/Closed/Error/Error and warning	Closed	Closed
Analogue input	4–20 mA/0–20 mA/0–10 V	4–20 mA	4–20 mA
Analogue output	4–20 mA/0–20 mA/0–10 V	4–20 mA	4–20 mA

8.4 Connection diagram

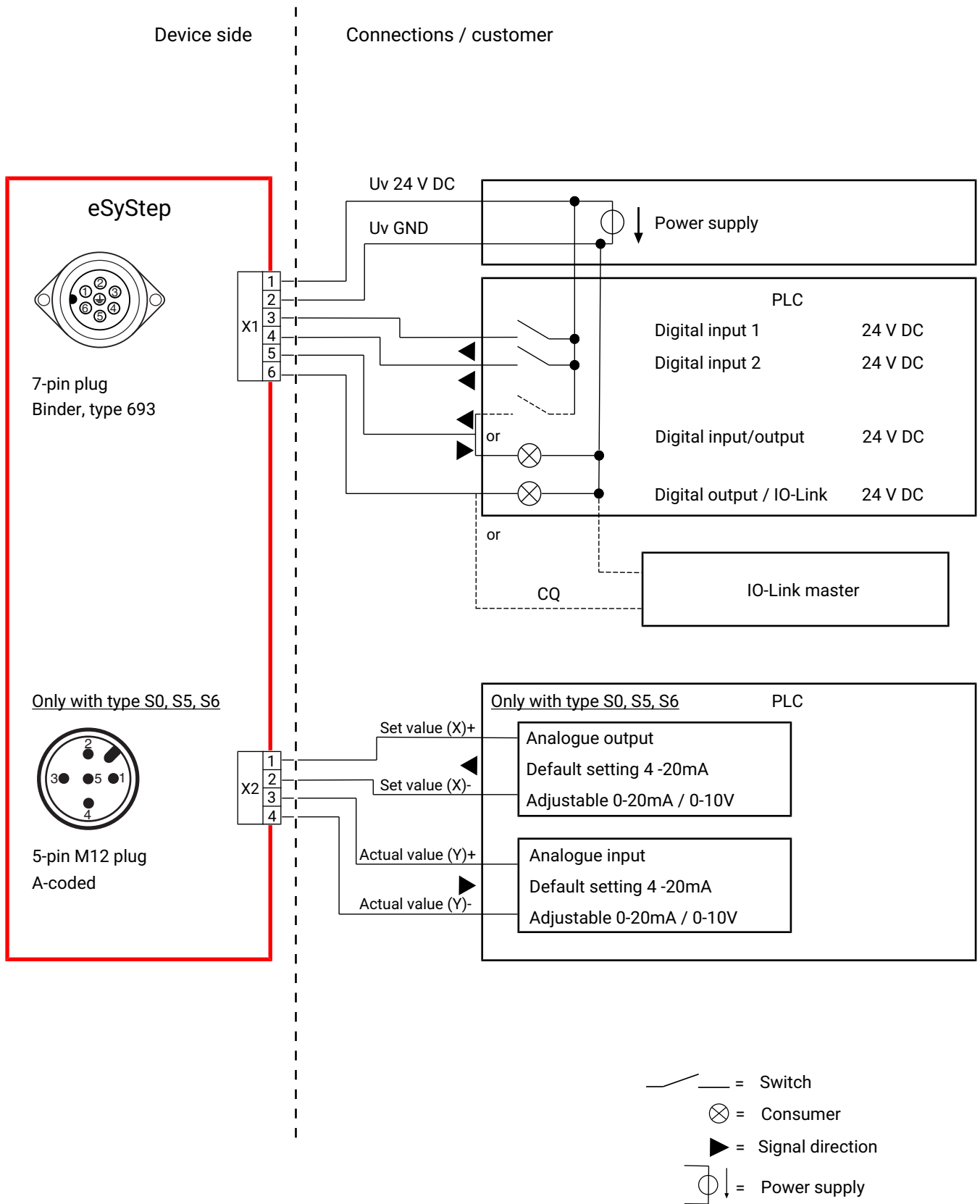

9 Dimensions

9.1 Actuator dimensions

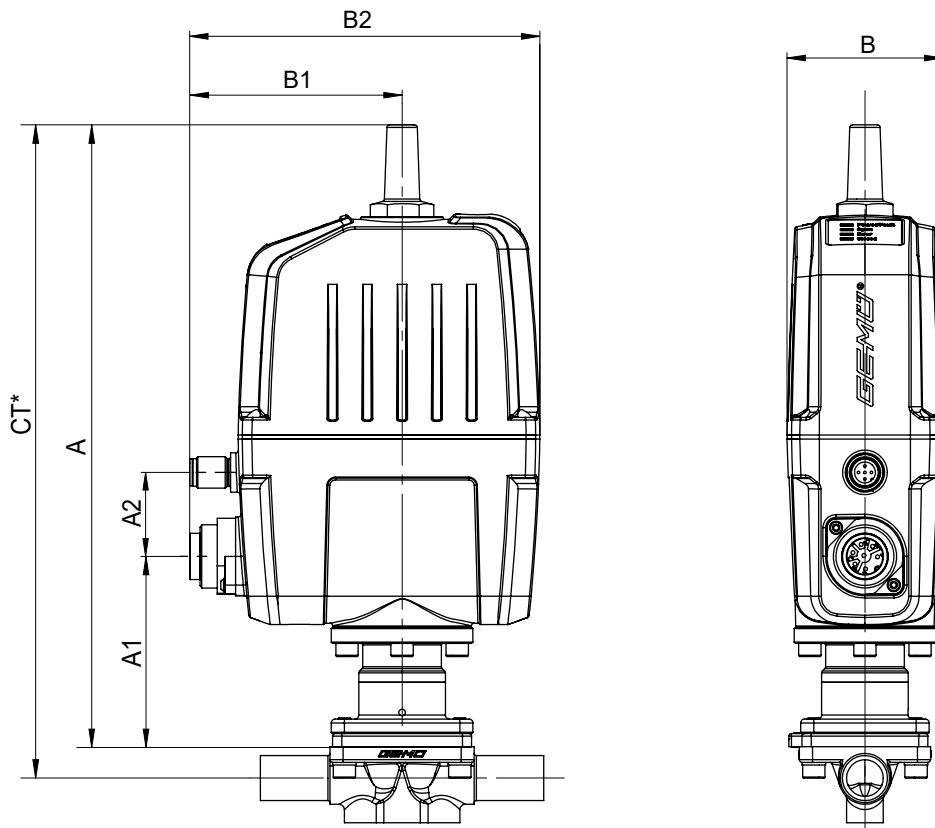

MG	DN	Actuator version	A	A1	A2	B	B1	B2
8	4 - 15	0B	222.5	58.0	33.2	59.4	81.0	133.5
10	10 - 20	0A	237.0	72.5	33.2	59.4	81.0	133.5
25	15 - 25	1A	306.0	124.0	32.5	70.0	82.0	150.0
40	32 - 40	1A	304.0	122.0	32.5	70.0	82.0	150.0

Dimensions in mm

MG = diaphragm size

* CT = A + H1 (see body dimensions)

9.2 Body dimensions

9.2.1 Spigot DIN/EN ISO (code 0, 16, 17, 18, 60)

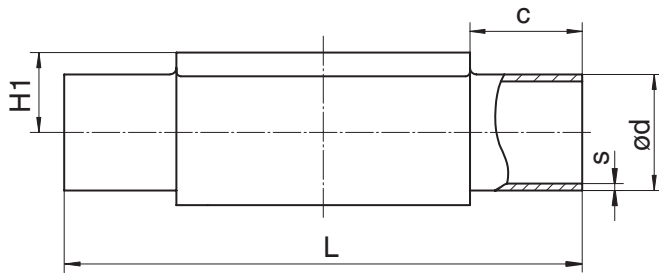

Connection type spigot DIN/EN/ISO (code 0, 16, 17, 18, 60)¹⁾, forged material (code 40, 42, F4)²⁾

MG	DN	NPS	c (min)	ød					H1	L	s				
				Connection type							Connection type				
				0	16	17	18	60			0	16	17	18	60
8	4	-	20.0	6.0	-	-	-	-	8.5	72.0	1.0	-	-	-	-
	6	-	20.0	-	-	8.0	-	10.2	8.5	72.0	-	-	1.0	-	1.6
	8	1/4"	20.0	-	-	10.0	-	13.5	8.5	72.0	-	-	1.0	-	1.6
	10	3/8"	20.0	-	12.0	13.0	14.0	-	8.5	72.0	-	1.0	1.5	2.0	-
10	10	3/8"	25.0	-	12.0	13.0	14.0	17.2	12.5	108.0	-	1.0	1.5	2.0	1.6
	15	1/2"	25.0	18.0	18.0	19.0	20.0	21.3	12.5	108.0	1.5	1.0	1.5	2.0	1.6
25	15	1/2"	25.0	18.0	18.0	19.0	20.0	21.3	19.0	120.0	1.5	1.0	1.5	2.0	1.6
	20	3/4"	25.0	22.0	22.0	23.0	24.0	26.9	19.0	120.0	1.5	1.0	1.5	2.0	1.6
	25	1"	25.0	28.0	28.0	29.0	30.0	33.7	19.0	120.0	1.5	1.0	1.5	2.0	2.0
40	32	1 1/4"	25.0	34.0	34.0	35.0	36.0	42.4	26.0	153.0	1.5	1.0	1.5	2.0	2.0
	40	1 1/2"	30.5	40.0	40.0	41.0	42.0	48.3	26.0	153.0	1.5	1.0	1.5	2.0	2.0

Dimensions in mm

MG = diaphragm size

1) Connection type

Code 0: Spigot DIN

Code 16: Spigot DIN EN 10357 series B (2014 edition; formerly DIN 11850 series 1)

Code 17: Spigot EN 10357 series A/DIN 11866 series A formerly DIN 11850 series 2

Code 18: Spigot DIN 11850 series 3

Code 60: Spigot ISO 1127/DIN EN 10357 series C (2014 edition)/DIN 11866 series B

2) Valve body material

Code 40: 1.4435 (F316L), forged body

Code 42: 1.4435 (BN2), forged body, Δ Fe < 0.5%

Code F4: 1.4539, forged body

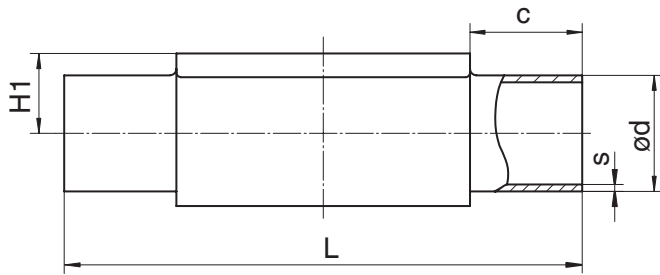

Connection type spigot DIN/EN/ISO (code 0, 17, 60)¹⁾, investment casting material (code C3)²⁾

MG	DN	NPS	c (min)	ød			H1	L	s		
				Connection type					Connection type		
				0	17	60			0	17	60
8	4	-	20.0	6,0	-	-	8.5	72.0	1,0	-	-
	6	-	20.0	-	8.0	-	8.5	72.0	-	1.0	-
	8	1/4"	20.0	-	10.0	13.5	8.5	72.0	-	1.0	1.6
	10	3/8"	20.0	-	13.0	-	8.5	72.0	-	1.5	-
10	10	3/8"	25.0	-	13.0	17.2	12.5	108.0	-	1.5	1.6
	15	1/2"	25.0	-	19.0	21.3	12.5	108.0	-	1.5	1.6
25	15	1/2"	25.0	-	19.0	21.3	13.0	120.0	-	1.5	1.6
	20	3/4"	25.0	-	23.0	26.9	16.0	120.0	-	1.5	1.6
	25	1"	25.0	-	29.0	33.7	19.0	120.0	-	1.5	2.0
40	32	1 1/4"	25.0	-	35.0	42.4	24.0	153.0	-	1.5	2.0
	40	1 1/2"	30.5	-	41.0	48.3	26.0	153.0	-	1.5	2.0

Dimensions in mm

MG = diaphragm size

1) **Connection type**

Code 0: Spigot DIN

Code 17: Spigot EN 10357 series A/DIN 11866 series A formerly DIN 11850 series 2

Code 60: Spigot ISO 1127/DIN EN 10357 series C (2014 edition)/DIN 11866 series B

2) **Valve body material**

Code C3: 1.4435, investment casting

9.2.2 Spigot ASME/BS (code 55, 59, 63, 64, 65)

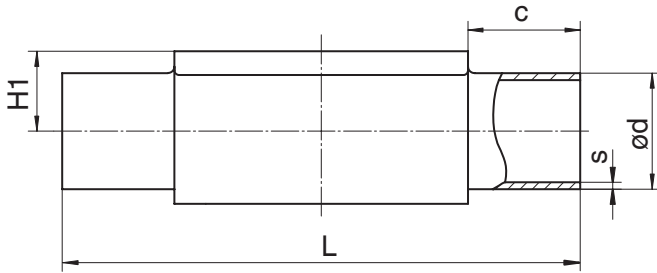

Connection type spigot ASME/BS (code 55, 59, 63, 64, 65)¹⁾, forged material (code 40, 42, F4)²⁾

MG	DN	NPS	c (min)	ød					H1	L	s				
				Connection type							Connection type				
				55	59	63	64	65			55	59	63	64	65
8	6	-	20.0	-	-	10.3	-	10.3	8.5	72.0	-	-	1.24	-	1.73
	8	1/4"	20.0	6.35	6.35	13.7	-	13.7	8.5	72.0	1.2	0.89	1.65	-	2.24
	10	3/8"	20.0	9.53	9.53	-	-	-	8.5	72.0	1.2	0.89	-	-	-
	15	1/2"	20.0	12.70	12.70	-	-	-	8.5	72.0	1.2	1.65	-	-	-
10	10	3/8"	25.0	9.53	9.53	17.1	-	17.1	12.5	108.0	1.2	0.89	1.65	-	2.31
	15	1/2"	25.0	12.70	12.70	21.3	21.3	21.3	12.5	108.0	1.2	1.65	2.11	1.65	2.77
	20	3/4"	25.0	19.05	19.05	-	-	-	12.5	108.0	1.2	1.65	-	-	-
25	15	1/2"	25.0	-	-	21.3	21.3	21.3	19.0	120.0	-	-	2.11	1.65	2.77
	20	3/4"	25.0	19.05	19.05	26.7	26.7	26.7	19.0	120.0	1.2	1.65	2.11	1.65	2.87
	25	1"	25.0	-	25.40	33.4	33.4	33.4	19.0	120.0	-	1.65	2.77	1.65	3.38
40	32	1 1/4"	25.0	-	-	42.2	42.2	42.2	26.0	153.0	-	-	2.77	1.65	3.56
	40	1 1/2"	30.5	-	38.10	48.3	48.3	48.3	26.0	153.0	-	1.65	2.77	1.65	3.68

Connection type spigot ASME BPE (code 59)¹⁾, investment casting material (code C3)²⁾

MG	DN	NPS	c (min)	ød	H1	L	s
8	8	1/4"	20.0	6.35	8.5	72.0	0.89
	10	3/8"	20.0	9.53	8.5	72.0	0.89
	15	1/2"	20.0	12.70	8.5	72.0	1.65
10	20	3/4"	25.0	19.05	12.5	108.0	1.65
25	20	3/4"	25.0	19.05	16.0	120.0	1.65
	25	1"	25.0	25.40	19.0	120.0	1.65
40	32	1 1/4"	25.0	-	-	153.0	-
	40	1 1/2"	30.5	38.10	26.0	153.0	1.65

Dimensions in mm

MG = diaphragm size

1) Connection type

Code 55: Spigot BS 4825, part 1

Code 59: Spigot ASME BPE/DIN EN 10357 series C (from 2022 edition)/DIN 11866 series C

Code 63: Spigot ANSI/ASME B36.19M schedule 10s

Code 64: Spigot ANSI/ASME B36.19M schedule 5s

Code 65: Spigot ANSI/ASME B36.19M schedule 40s

2) Valve body material

Code 40: 1.4435 (F316L), forged body

Code 42: 1.4435 (BN2), forged body, Δ Fe < 0.5%

Code C3: 1.4435, investment casting

Code F4: 1.4539, forged body

9.2.3 Spigot JIS/SMS (code 35, 36, 37)

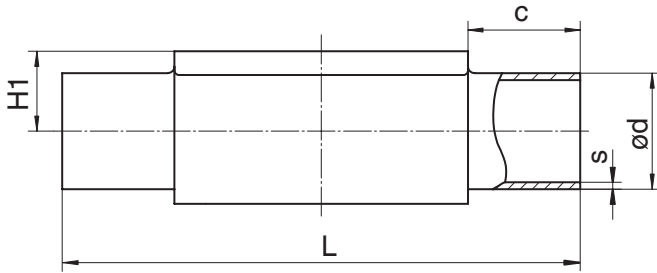
Connection type spigot JIS/SMS (code 35, 36, 37)¹⁾, forged material (code 40, 42, F4)²⁾

MG	DN	NPS	c (min)	ød			H1	L	s		
				Connection type					Connection type		
				35	36	37			35	36	37
8	6	-	20.0	-	10.5	-	8.5	72.0	-	1.20	-
	8	1/4"	20.0	-	13.8	-	8.5	72.0	-	1.65	-
10	10	3/8"	25.0	-	17.3	-	12.5	108.0	-	1.65	-
	15	1/2"	25.0	-	21.7	-	12.5	108.0	-	2.10	-
25	15	1/2"	25.0	-	21.7	-	19.0	120.0	-	2.10	-
	20	3/4"	25.0	-	27.2	-	19.0	120.0	-	2.10	-
	25	1"	25.0	25.4	34.0	25.0	19.0	120.0	1.2	2.80	1.2
40	32	1 1/4"	25.0	31.8	42.7	33.7	26.0	153.0	1.2	2.80	1.2
	40	1 1/2"	30.5	38.1	48.6	38.0	26.0	153.0	1.2	2.80	1.2

Connection type spigot SMS (code 37)¹⁾, investment casting material (code C3)²⁾

MG	DN	NPS	c (min)	ød	H1	L	s
25	25	1"	25.0	25.0	19.0	120.0	1.2
40	40	1 1/2"	30.5	38.0	26.0	153.0	1.2

Dimensions in mm

MG = diaphragm size

1) Connection type

Code 35: Spigot JIS-G 3447

Code 36: Spigot JIS-G 3459 schedule 10s

Code 37: Spigot SMS 3008

2) Valve body material

Code 40: 1.4435 (F316L), forged body

Code 42: 1.4435 (BN2), forged body, Δ Fe < 0.5%

Code C3: 1.4435, investment casting

Code F4: 1.4539, forged body

9.2.4 Threaded socket DIN (code 1)

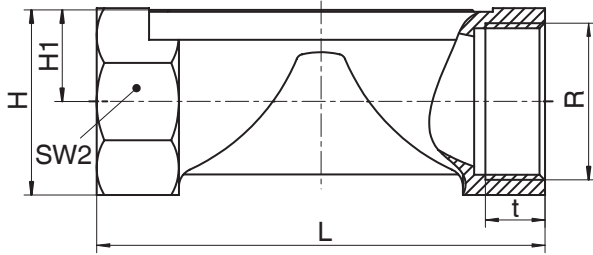

Connection type threaded socket (code 1)¹⁾, brass material (code 12)²⁾

MG	DN	NPS	H	H1	L	n	R	SW 2	t
10	12	3/8"	23.0	11.0	55.0	2	G 3/8	22.0	13.0
	15	1/2"	29.0	14.0	75.0	2	G 1/2	25.0	15.0

Connection type threaded socket (code 1)¹⁾, investment casting material (code 37)²⁾

MG	DN	NPS	H	H1	L	n	R	SW 2	t
8	8	1/4"	19.0	9.0	72.0	6	G 1/4	18.0	11.0
10	12	3/8"	25.0	13.0	55.0	2	G 3/8	22.0	12.0
	15	1/2"	30.0	15.0	68.0	2	G 1/2	27.0	15.0
25	15	1/2"	28.3	14.8	85.0	6	G 1/2	27.0	15.0
	20	3/4"	33.3	17.3	85.0	6	G 3/4	32.0	16.0
	25	1"	42.3	21.8	110.0	6	G 1	41.0	13.0
40	32	1 1/4"	51.3	26.3	120.0	8	G 1 1/4	50.0	20.0
	40	1 1/2"	56.3	28.8	140.0	8	G 1 1/2	55.0	18.0

Connection type threaded socket (code 1)¹⁾, SG iron material (code 90)²⁾

MG	DN	NPS	H	H1	L	n	R	SW 2	t
25	15	1/2"	32.7	16.7	85.0	6	G 1/2	32	15.0
	20	3/4"	42.0	21.5	85.0	6	G 3/4	41	16.3
	25	1"	46.7	23.7	110.0	6	G 1	46	19.1
40	32	1 1/4"	56.0	28.5	120.0	6	G 1 1/4	55	21.4
	40	1 1/2"	66.0	33.5	140.0	6	G 1 1/2	65	21.4

Dimensions in mm

MG = diaphragm size

n = number of flats

1) Connection type

Code 1: Threaded socket DIN ISO 228

2) Valve body material

Code 12: CW614N, CW617N (brass)

Code 37: 1.4408, investment casting

Code 90: EN-GJS-400-18-LT (GGG 40.3)

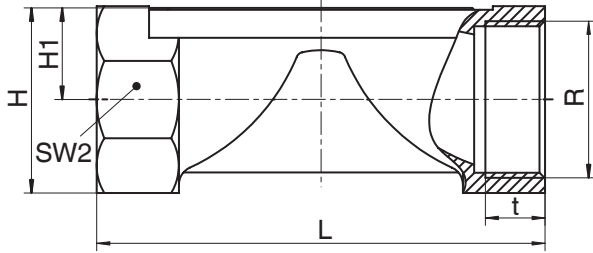
9.2.5 Threaded socket NPT (code 31)**Connection type threaded socket NPT (code 31)¹⁾, investment casting material (code 37)²⁾**

MG	DN	NPS	H	H1	L	n	R	SW 2	t
25	15	1/2"	28.3	14.8	85.0	6	NPT 1/2	27.0	14.0
	20	3/4"	33.3	17.3	85.0	6	NPT 3/4	32.0	14.0
	25	1"	42.3	21.8	110.0	6	NPT 1	41.0	17.0
40	32	1 1/4"	51.3	26.3	120.0	8	NPT 1 1/4	50.0	17.0
	40	1 1/2"	56.3	28.8	140.0	8	NPT 1 1/2	55.0	17.0

Connection type threaded socket NPT (code 31)¹⁾, SG iron material (code 90)²⁾

MG	DN	NPS	H	H1	L	n	R	SW 2	t
25	15	1/2"	32.7	16.7	85.0	6	NPT 1/2	32	13.6
	20	3/4"	42.0	21.5	85.0	6	NPT 3/4	41	14.1
	25	1"	46.7	23.7	110.0	6	NPT 1	46	16.8
40	32	1 1/4"	56.0	28.5	120.0	6	NPT 1 1/4	55	17.3
	40	1 1/2"	66.0	33.5	140.0	6	NPT 1 1/2	65	17.3

Dimensions in mm

MG = diaphragm size

n = number of flats

1) Connection type

Code 31: NPT female thread

2) Valve body material

Code 37: 1.4408, investment casting

Code 90: EN-GJS-400-18-LT (GGG 40.3)

9.2.6 Threaded spigot DIN (code 6)

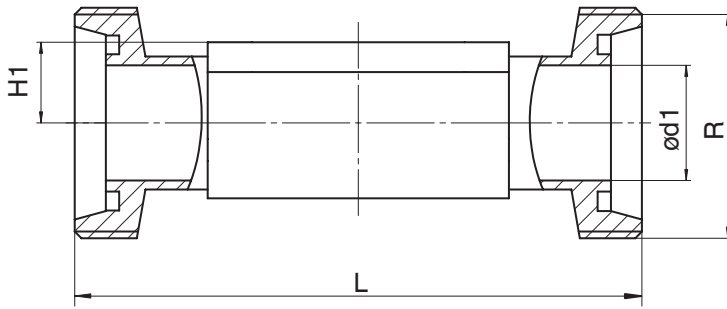

Connection type threaded spigot DIN (code 6)¹⁾, forged material (code 40, 42)²⁾

MG	DN	NPS	ød1	H1	L	R
8	10	3/8"	10.0	8.5	92.0	Rd 28 x 1/8
10	10	3/8"	10.0	12.5	118.0	Rd 28 x 1/8
	15	1/2"	16.0	12.5	118.0	Rd 34 x 1/8
25	15	1/2"	16.0	19.0	118.0	Rd 34 x 1/8
	20	3/4"	20.0	19.0	118.0	Rd 44 x 1/6
	25	1"	26.0	19.0	128.0	Rd 52 x 1/6
40	32	1¼"	32.0	26.0	147.0	Rd 58 x 1/6
	40	1½"	38.0	26.0	160.0	Rd 65 x 1/6

Dimensions in mm

MG = diaphragm size

1) **Connection type**

Code 6: Threaded spigot DIN 11851

2) **Valve body material**

Code 40: 1.4435 (F316L), forged body

Code 42: 1.4435 (BN2), forged body, Δ Fe < 0.5%

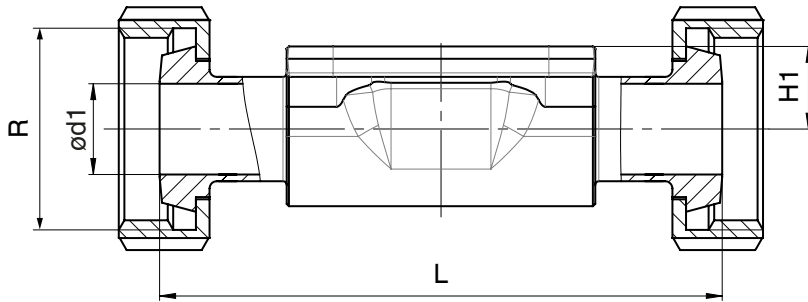
9.2.7 Cone spigot DIN (code 6K)**Connection type cone spigot DIN (code 6K)¹⁾, forged material (code 40, 42)²⁾**

MG	DN	NPS	$\varnothing d1$	H1	L	R
8	10	3/8"	10.0	8.5	90.0	Rd 28 x 1/8
10	10	3/8"	10.0	12.5	116.0	Rd 28 x 1/8
	15	1/2"	16.0	12.5	116.0	Rd 34 x 1/8
25	15	1/2"	16.0	19.0	116.0	Rd 34 x 1/8
	20	3/4"	20.0	19.0	114.0	Rd 44 x 1/6
	25	1"	26.0	19.0	127.0	Rd 52 x 1/6
40	32	1 1/4"	32.0	26.0	147.0	Rd 58 x 1/6
	40	1 1/2"	38.0	26.0	160.0	Rd 65 x 1/6

Dimensions in mm

MG = diaphragm size

1) Connection type

Code 6K: Cone spigot and union nut DIN 11851

2) Valve body material

Code 40: 1.4435 (F316L), forged body

Code 42: 1.4435 (BN2), forged body, $\Delta Fe < 0.5\%$

9.2.8 Flange EN (code 8)

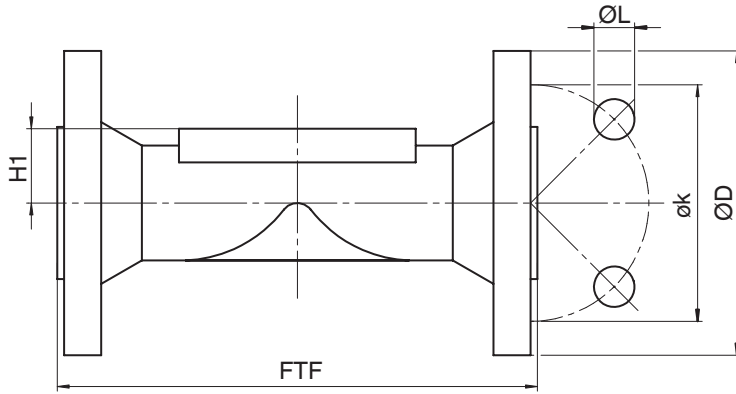

Connection type flange, length EN 558 (code 8)¹⁾, SG iron material (code 17, 18, 83, 90), investment casting material (code 39, C3), forged material (code 40, 42)²⁾

MG	DN	NPS	øD	FTF		H1				øk	øL	n
				Material		Material						
				17, 18, 39, 83, 90	40, 42, C3	17, 18, 39, 83	40, 42	C3	90			
25	15	1/2"	95.0	130.0	150.0	18.0	19.0	13.0	14.0	65.0	14.0	4
	20	3/4"	105.0	150.0	150.0	20.5	19.0	16.0	16.5	75.0	14.0	4
	25	1"	115.0	160.0	160.0	23.0	19.0	19.0	19.5	85.0	14.0	4
40	32	1¼"	140.0	180.0	180.0	28.7	26.0	24.0	23.0	100.0	19.0	4
	40	1½"	150.0	200.0	200.0	33.0	26.0	26.0	27.0	110.0	19.0	4

Dimensions in mm

MG = diaphragm size

n = number of bolt holes

1) Connection type

Code 8: Flange EN 1092, PN 16, form B, face-to-face dimension FTF EN 558 series 1, ISO 5752, basic series 1, length only for body configuration D

2) Valve body material

Code 17: EN-GJS-400-18-LT (GGG 40.3), PFA lined

Code 18: EN-GJS-400-18-LT (GGG 40.3), PP lined

Code 39: 1.4408, PFA lined

Code 40: 1.4435 (F316L), forged body

Code 42: 1.4435 (BN2), forged body, Δ Fe < 0.5%

Code 83: EN-GJS-400-18-LT (GGG 40.3), hard rubber lined

Code 90: EN-GJS-400-18-LT (GGG 40.3)

Code C3: 1.4435, investment casting

9.2.9 Flange JIS (code 34)

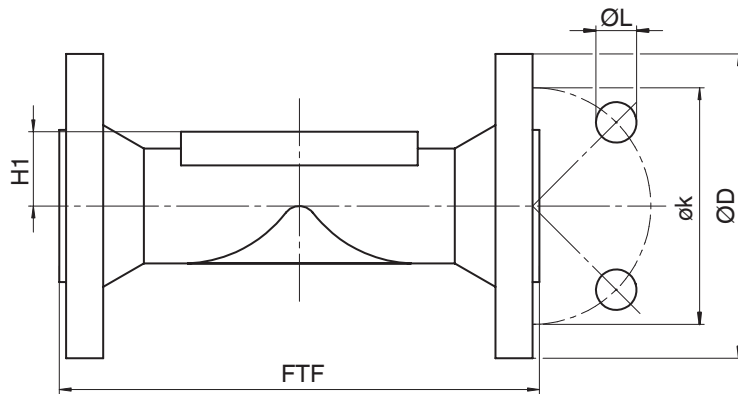
Connection type flange, length 558 (code 34)¹⁾, investment casting material (code 39)²⁾

MG	DN	NPS	øD	FTF	H1	øk	øL	n
25	15	1/2"	95.0	130.0	18.0	70.0	15.0	4
	20	3/4"	100.0	150.0	20.5	75.0	15.0	4
	25	1"	125.0	160.0	23.0	90.0	19.0	4
40	32	1¼"	135.0	180.0	28.7	100.0	19.0	4
	40	1½"	140.0	200.0	33.0	105.0	19.0	4

Dimensions in mm

MG = diaphragm size

1) Connection type

Code 34: Flange JIS B2220, 10K, RF, face-to-face dimension FTF EN 558 series 1, ISO 5752, basic series 1, length only for body configuration D

2) Valve body material

Code 39: 1.4408, PFA lined

9.2.10 Flange ANSI Class (code 38, 39)

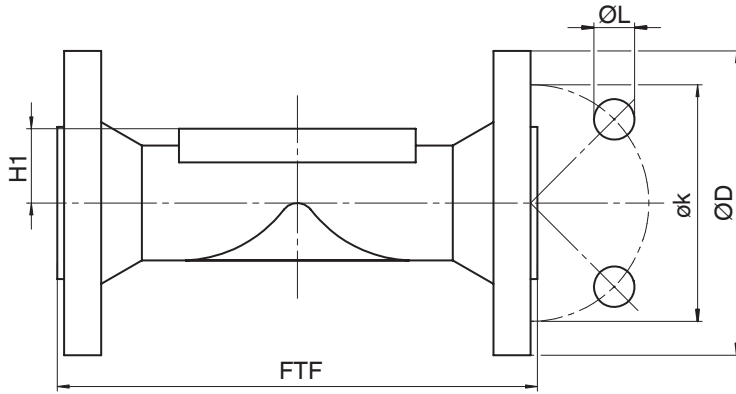

Connection type flange, length MSS SP-88 (code 38)¹⁾, SG iron material (code 17, 18, 83), investment casting material (code 39)²⁾

MG	DN	NPS	øD	FTF		H1	øk	øL	n
				Material					
				17, 39	82, 83, 88				
25	20	3/4"	100.0	146.0	146.4	20.5	69.9	15.9	4
	25	1"	110.0	146.0	146.4	23.0	79.4	15.9	4
40	40	1½"	125.0	175.0	171.4	33.0	98.4	15.9	4

Connection type flange, length EN 558 (code 39)¹⁾, SG iron material (code 17, 18, 83, 90), investment casting material (code 39, C3), forged material (code 40, 42)²⁾

MG	DN	NPS	øD	FTF		H1				øk	øL	n
				Material		Material						
				17, 18, 39, 83, 90	40, 42, C3	17, 18, 39, 83	C3	40, 42	90			
25	15	1/2"	90.0	130.0	150.0	-	13.0	19.0	14.0	60.3	15.9	4
	20	3/4"	100.0	150.0	150.0	20.5	16.0	19.0	16.5	69.9	15.9	4
	25	1"	110.0	160.0	160.0	23.0	19.0	19.0	19.5	79.4	15.9	4
40	32	1¼"	115.0	180.0	180.0	28.7	24.0	26.0	23.0	88.9	15.9	4
	40	1½"	125.0	200.0	200.0	33.0	26.0	26.0	27.0	98.4	15.9	4

Dimensions in mm

MG = diaphragm size

n = number of bolt holes

1) Connection type

Code 38: Flange ANSI Class 150 RF, face-to-face dimension FTF MSS SP-88, length only for body configuration D

Code 39: Flange ANSI Class 125/150 RF, face-to-face dimension FTF EN 558 series 1, ISO 5752, basic series 1, length only for body configuration D

2) Valve body material

Code 17: EN-GJS-400-18-LT (GGG 40.3), PFA lined

Code 18: EN-GJS-400-18-LT (GGG 40.3), PP lined

Code 39: 1.4408, PFA lined

Code 40: 1.4435 (F316L), forged body

Code 42: 1.4435 (BN2), forged body, Δ Fe < 0.5%

Code 83: EN-GJS-400-18-LT (GGG 40.3), hard rubber lined

Code 90: EN-GJS-400-18-LT (GGG 40.3)

Code C3: 1.4435, investment casting

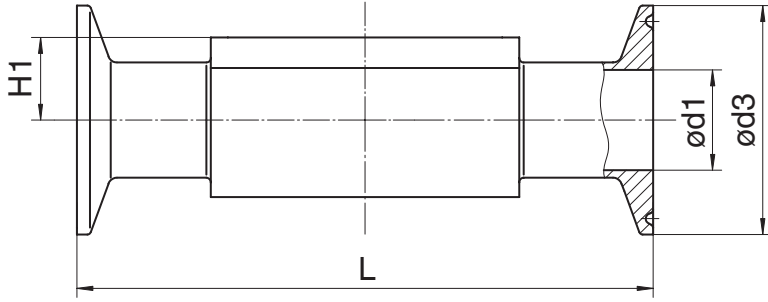
9.2.11 Clamp (code 80, 82, 88, 8A, 8E, 8P, 8T)**Connection type clamp DIN/ASME (code 80, 88, 8P, 8T), forged material (code 40, 42, F4)¹⁾**

MG	DN	NPS	ød1		ød3		H1	L	
			Connection type		Connection type			Connection type	
			80, 8P	88, 8T	80, 8P	88, 8T		80, 8P	88, 8T
8	8	1/4"	4.57	-	25.0	-	8.5	63.5	-
	10	3/8"	7.75	-	25.0	-	8.5	63.5	-
	15	1/2"	9.40	9.40	25.0	25.0	8.5	63.5	108.0
10	15	1/2"	9.40	9.40	25.0	25.0	12.5	88.9	108.0
	20	3/4"	15.75	15.75	25.0	25.0	12.5	101.6	117.0
25	20	3/4"	15.75	15.75	25.0	25.0	19.0	101.6	117.0
	25	1"	22.10	22.10	50.5	50.5	19.0	114.3	127.0
40	40	1½"	34.80	34.80	50.5	50.5	26.0	139.7	159.0

Dimensions in mm

MG = diaphragm size

1) Valve body material

Code 40: 1.4435 (F316L), forged body

Code 42: 1.4435 (BN2), forged body, Δ Fe < 0.5%

Code F4: 1.4539, forged body

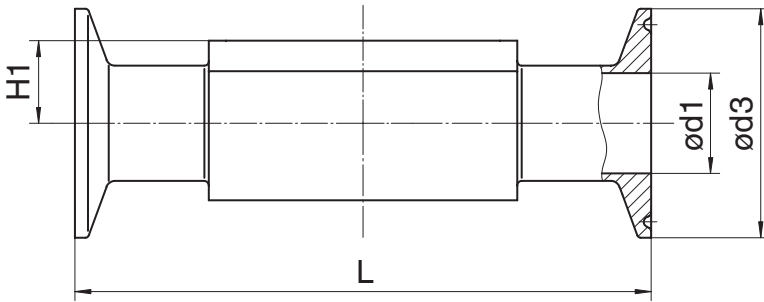

Connection type clamp DIN/ISO (code 82, 8A, 8E), forged material (code 40, 42, F4) ¹⁾

MG	DN	NPS	ød1			ød3			H1	L		
			Connection type			Connection type				Connection type		
			82	8A	8E	82	8A	8E		82	8A	8E
8	6	1/8"	7.0	6.0	-	25.0	25.0	-	8.5	63.5	63.5	-
	8	1/4"	10.3	8.0	-	25.0	25.0	-	8.5	63.5	63.5	-
	10	3/8"	-	10.0	-	-	34.0	-	8.5	-	88.9	-
10	10	3/8"	14.0	10.0	-	25.0	34.0	-	12.5	108.0	108.0	-
	15	1/2"	18.1	16.0	-	50.5	34.0	-	12.5	108.0	108.0	-
25	15	1/2"	18.1	16.0	-	50.5	34.0	-	19.0	108.0	108.0	-
	20	3/4"	23.7	20.0	-	50.5	34.0	-	19.0	117.0	117.0	-
	25	1"	29.7	26.0	22.6	50.5	50.5	50.5	19.0	127.0	127.0	127.0
40	32	1 1/4"	38.4	32.0	31.3	64.0	50.5	50.5	26.0	146.0	146.0	146.0
	40	1 1/2"	44.3	38.0	35.6	64.0	50.5	50.5	26.0	159.0	159.0	159.0

Dimensions in mm

MG = diaphragm size

1) **Valve body material**

Code 40: 1.4435 (F316L), forged body

Code 42: 1.4435 (BN2), forged body, Δ Fe < 0.5%

Code F4: 1.4539, forged body

10 Manufacturer's information

10.1 Delivery

- Check that all parts are present and check for any damage immediately upon receipt.

The product's performance is tested at the factory. The scope of delivery is apparent from the dispatch documents and the design from the order number.

10.2 Packaging

The product is packaged in a cardboard box which can be recycled as paper.

10.3 Transport







1. Only transport the product by suitable means. Do not drop. Handle carefully.
2. After the installation dispose of transport packaging material according to relevant local or national disposal regulations / environmental protection laws.



10.4 Storage

1. Store the product free from dust and moisture in its original packaging.
2. Avoid UV rays and direct sunlight.
3. Do not exceed the maximum storage temperature (see chapter "Technical data").
4. Do not store solvents, chemicals, acids, fuels or similar fluids in the same room as GEMÜ products and their spare parts.
5. Close the compressed air connections with protection caps or sealing plugs.

11 Installation in piping

11.1 Preparing for installation

 WARNING	
	<p>The equipment is subject to pressure!</p> <ul style="list-style-type: none"> ▶ Risk of severe injury or death! ● Depressurize the plant or plant component. ● Completely drain the plant or plant component.
 WARNING	
	<p>Corrosive chemicals!</p> <ul style="list-style-type: none"> ▶ Risk of caustic burns ● Wear appropriate protective gear. ● Completely drain the plant.
 CAUTION	
	<p>Hot plant components!</p> <ul style="list-style-type: none"> ▶ Risk of burns ● Only work on plant that has cooled down.

 CAUTION	
	<p>Maximum permissible pressure exceeded.</p> <ul style="list-style-type: none"> ▶ Damage to the product! ● Provide for precautionary measures against exceeding the maximum permissible pressure that may be caused by pressure surges (water hammer).

 CAUTION	
Use as step!	
<ul style="list-style-type: none"> ▶ Damage to the product ▶ Risk of slipping-off ● Choose the installation location so that the product cannot be used as a foothold. ● Do not use the product as a step or a foothold. 	

NOTICE	
Suitability of the product!	
<ul style="list-style-type: none"> ▶ The product must be appropriate for the piping system operating conditions (medium, medium concentration, temperature and pressure) and the prevailing ambient conditions. 	

NOTICE	
Tools!	
<ul style="list-style-type: none"> ▶ The tools required for installation and assembly are not included in the scope of delivery. ● Use appropriate, functional and safe tools. 	

1. Ensure the product is suitable for the relevant application.
2. Check the technical data of the product and the materials.
3. Keep appropriate tools ready.
4. Wear appropriate protective gear, as specified in the plant operator's guidelines.
5. Observe appropriate regulations for connections.
6. Have installation work carried out by trained personnel.
7. Shut off plant or plant component.
8. Secure plant or plant component against recommissioning.
9. Depressurize the plant or plant component.
10. Completely drain the plant (or plant component) and let it cool down until the temperature is below the media vaporization temperature and cannot cause scalding.
11. Correctly decontaminate, rinse and ventilate the plant or plant component.
12. Lay piping so that the product is protected against transverse and bending forces, and also from vibrations and tension.
13. Only install the product between matching aligned pipes (see chapters below).

11.2 Installation position

The installation position of the product is optional.

11.3 Installation with clamp connections

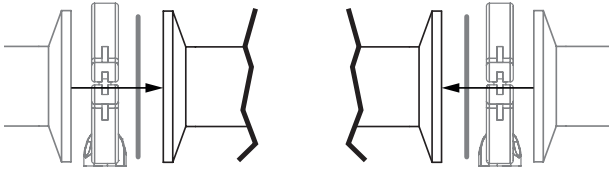

Fig. 1: Clamp connection

NOTICE

Gasket and clamp!

► The gasket and clamps for clamp connections are not included in the scope of delivery.

1. Keep ready gasket and clamp.
2. Carry out preparation for installation (see chapter "Preparing for installation").
3. Insert the corresponding gasket between the body of the product and the pipe connection.
4. Connect the gasket between the body of the product and the pipe connection using clamps.
5. Re-attach or reactivate all safety and protective devices.

11.4 Installation with butt weld spigots

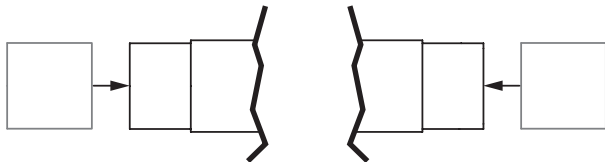

Fig. 2: Butt weld spigots

1. Carry out preparations for installation (see chapter "Preparing for installation").
2. Adhere to good welding practices!
3. Disassemble the actuator with the diaphragm before welding in the valve body (see "Removing the actuator" chapter).
4. Weld the body of the product in the piping.
5. Allow butt weld spigots to cool down.
6. Reassemble the valve body and the actuator with diaphragm (see "Mounting the actuator" chapter).
7. Re-attach or reactivate all safety and protective devices.
8. Flush the system.

11.5 Installation with threaded sockets

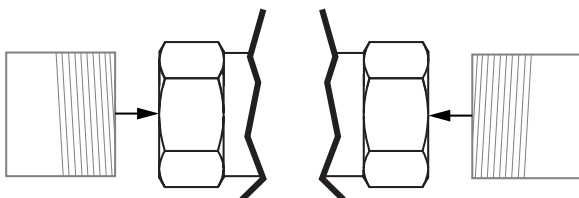

Fig. 3: Threaded socket

NOTICE

Sealing material!

- The sealing material is not included in the scope of delivery.
- Only use appropriate sealing material.

1. Keep thread sealant ready.
2. Carry out preparations for installation (see chapter "Preparing for installation").
3. Screw the threaded connections into the pipe in accordance with valid standards.
4. Screw the body of the product onto the piping using appropriate thread sealant.
5. Re-attach or reactivate all safety and protective devices.

11.6 Installation with threaded spigots

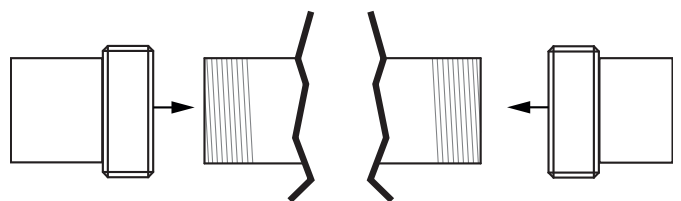

Fig. 4: Threaded spigots

NOTICE

Thread sealant!

- The thread sealant is not included in the scope of delivery.
- Only use appropriate thread sealant.

1. Keep thread sealant ready.
2. Carry out preparations for installation (see chapter "Preparing for installation").
3. Screw the pipe into the threaded connection of the valve body in accordance with valid standards.
 - ⇒ Use appropriate thread sealant.
4. Re-attach or reactivate all safety and protective devices.

12 Specific data IO-Link (pin 6)

IO-Link process data and parameters can be set via pin 6 for the motorized linear actuator eSyStep. The assignment of the connectors and the current consumption of the actuator are non-compliant with the IO-Link specification.

12.1 Operation on IO-Link

12.1.1 Operation on PLC as a 24 V device

The motorized actuator GEMÜ eSyStep can be operated directly in a PLC control unit without limitations. Technical data of the product and of PLC must be complied with.

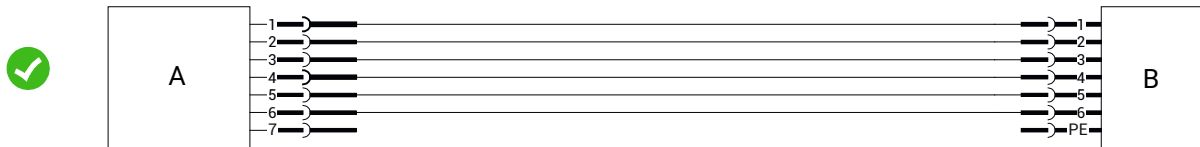

Item	Name
A	eSyStep
B	PLC with supply voltage

12.1.2 Operation on PLC and additional parameterization via USB master with galvanic isolation

Basics

When operating the product on a PLC control unit, a parameterization via a USB IO-Link master is possible at the same time. In this case, a galvanically isolated USB interface must be used. The PC/laptop can be used as usual and all peripheral devices can remain connected.

Connection

1. Connect **pin 3 (L-)** of the master with **pin 2 (GND)** of the product.
2. Connect **pin 4 (CQ)** of the master with **pin 6** of the product.

During IO-Link operation, pin 6 **cannot** be evaluated by the PLC control unit as an output signal.

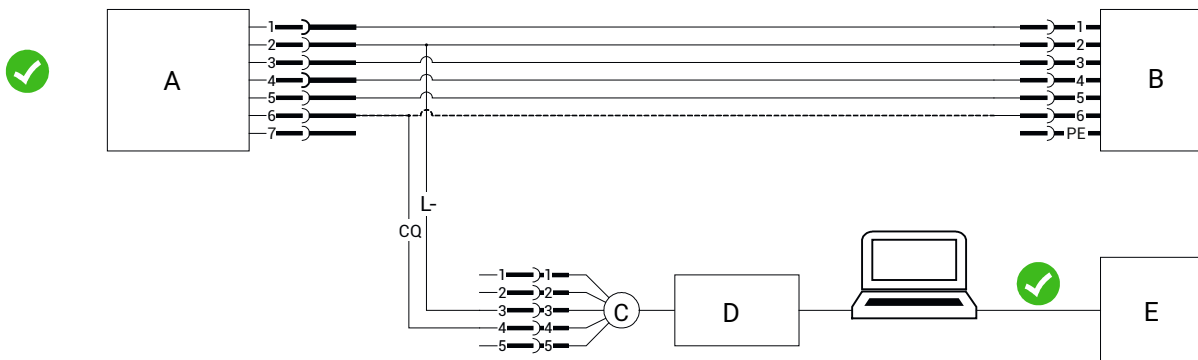

Item	Name
A	eSyStep
B	PLC with supply voltage
C	USB IO-Link Master
D	Galvanically isolated USB interface
E	Mains plug – laptop

12.1.3 Operation on PLC and additional parameterization via USB master without galvanic isolation

Basics

Only one laptop can be used if no galvanic isolation is available for the USB interface during communication via a USB IO-Link master. No other peripheral devices may be connected to the laptop. The laptop may only be operated without a power supply unit.

If further peripheral devices and the power supply unit are not disconnected, different ground potentials to the product can result in excessive compensating currents. These can damage the USB interface of the laptop, the connected peripheral devices or the USB IO-Link master.

Connection

1. Connect **pin 3 (L-)** of the master with **pin 2 (GND)** of the product.
2. Connect **pin 4 (CQ)** of the master with **pin 6** of the product.

During IO-Link operation, pin 6 **cannot** be evaluated by the PLC control unit as an output signal.

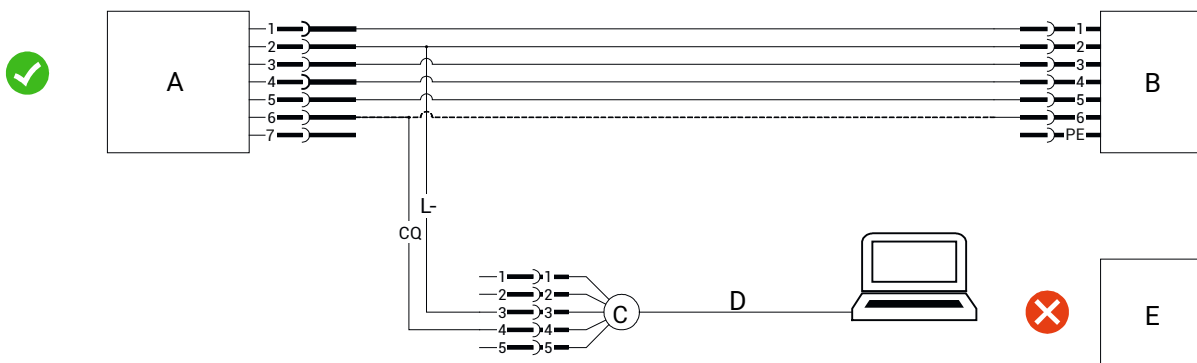

Item	Name
A	eSyStep
B	PLC with supply voltage
C	USB IO-Link Master
D	USB interface
E	Mains plug – laptop

12.1.4 Direct operation on the IO-Link master

Basics

If the product is to be operated on an IO-Link master, it must be ensured that the **GND** levels in the product and in the IO-Link master have the same potential so that there are no compensating currents which would cause damage in the system. This can be made possible using several procedures.

12.1.4.1 Identical power supply

The IO-Link master is operated from the same power supply as the product.

- Connect **pin 4 (CQ)** of the master with **pin 6** of the product.

However, **pin 3 (L-)** of the master should **not** be connected to **pin 2 (GND)** of the product under any circumstances.

This prevents a ground loop and no unexpected high currents can occur via **pin 3 (L-)** which can damage the master.

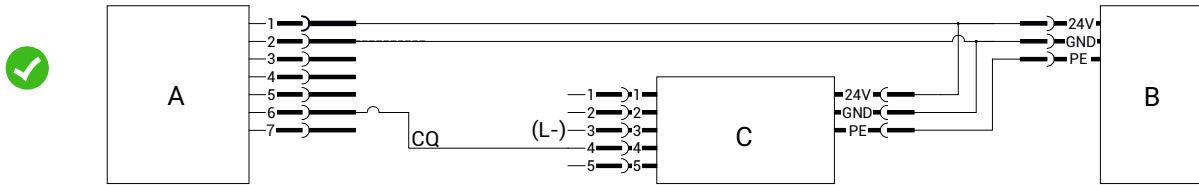

Item	Name
A	eSyStep
B	Supply voltage
C	USB IO-Link Master

12.1.4.2 Separate power supply, GND-connected

The IO-Link master and the product can also be operated with different power supply sources if the **GND** of both power supply sources is connected. In this case, the master is connected as when the power supply is identical

- Connect **pin 4 (CQ)** IO-Link master with **pin 6** of the product.

Do **not** connect (**pin 3**) L- IO-Link master.

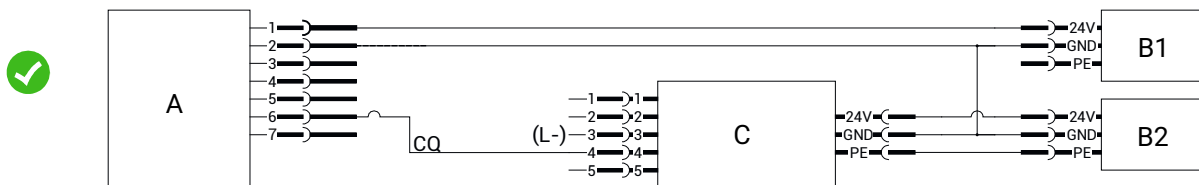

Item	Name
A	eSyStep
B1 and B2	Supply voltages
C	USB IO-Link Master

12.2 Process data

The motorized linear actuator has access to process data via the IO-Link. This is transmitted in cycles with every IO-Link telegram.

Master → Device

Name	Bit	Values
Drive go Open	0	0 → Actuator does not move into position Open
		1 → Actuator moves into position Open
Drive go Close	1	0 → Actuator does not move into position Closed
		1 → Actuator moves into position Closed
Start initialization	2	0 → No initialization
		1 → Start initialization
Locate	3	0 → Off
		1 → On
Setpoint analog	8 ... 23	Setpoint in the range 0 ... 1000

Device → Master

Name	Bit	Values
Valve position Open	0	0 → Process valve not in Open position
		1 → Process valve in Open position
Valve position Close	1	0 → Process valve not in Closed position
		1 → Process valve in Closed position
Operating mode	2	0 → Normal operation
		1 → Initialization mode
Valve position analog	8 ... 23	Position of the valve in the range 0 ... 1000

12.3 Parameter overview

NOTICE							
▶ All IO-Link parameters that contain sub-indexes can also be addressed in bundles via sub-index 0.							
Index	Sub-Index	Access rights	Index name	Parameter	Function	Default settings	Setting options
0x02	0	W	System command		Transmission of commands for block parameterization and data storage		0x01 to 0x06 0x82
0x03	1	R/W	Data storage index	Data storage cmd	Saving and restoring parameter data for device identical in construction		
	2	RO		State property			
	3	RO		Data storage size			
	4	RO		Parameter checksum			
	5	RO		Index list			
0x0C	1	R/W	Device access locks	Parameter (write) access	Parameter write protection		0 → unlocked 1 → locked
	2	R/W		Data storage	Data memory		0 → unlocked 1 → locked
	3	R/W		Local parameterization	Local parameterization		0 → unlocked 1 → locked
	4	R/W		Local user interface	Local user interface		0 → unlocked 1 → locked
0x0D	0	RO	Profile characteristics		Supported Device Profile IDs, Common Application Profile IDs, Function Class IDs	0x8000 (Device Ident. Objects) 0x8002 (Process Data Mapping) 0x8003 (Diagnosis) 0x8100 (Ext. Identification)	
0x0E	0	RO	Process data input descriptor		Data format of input process data		0x00 (Bit offset) 0x03 (Type Length) 0x01 (DataType -> BoolT)
0x0F	0	RO	Process data output descriptor		Data format of output process data		0x00 (Bit offset) 0x04 (Type Length) 0x01 (DataType -> BoolT)
0x10	0	RO	Vendor name		Read out manufacturer name		"GEMUE"
0x12	0	RO	Product name		Read out device name		"eSyStep Positioner"
0x13	0	RO	Product ID		Read out product ID		"eSyStep Positioner"
0x15	0	RO	Serial number		Read out serial number		"XXXXXXXX/YYYY"
0x16	0	RO	Hardware revision		Read out hardware version		"Rev. XX/XX"
0x17	0	RO	Firmware revision		Read out software version		"V X.X.X.X."

Index	Sub-Index	Access rights	Index name	Parameter	Function	Default settings	Setting options
0x18	0	R/W	Application specific tag		Text with 32 characters can be entered		*****"
0x19	0	R/W	Function tag		Text with 32 characters can be entered		*****"
0x1A	0	R/W	Location tag		Text with 32 characters can be entered		*****"
0x24	0	RO	Device status		(Simple) device status		0 → Operating properly 2 → Out of specification 4 → Failure
0x25	0	RO	Device status		Detailed device status		
0x40	0	RO	Actuator size		Read out actuator size	Depending on the actuator size used	0 → Actuator size 0 1 → Actuator size 1 2 → Actuator size 2
0x4B	1	R/W	Function digital inputs	Input 1	Configure digital input 1	4	0 → Off 1 → Open 2 → Close 3 → Safe/On 4 → Init
	2	R/W		Input 2	Configure digital input 2	0	0 → Off 1 → Open 2 → Close 3 → Safe/On 4 → Init
0x4C	1	R/W	Function digital in/output 1	In- / output 1	Configure digital inputs/outputs	2	0 → Output open 1 → Output close 2 → Output error 3 → Output Error & warning 4 → Input init
	2	R/W		Type in- / output 1	Configure type of digital inputs/outputs	0	0 → Push-pull 1 → NPN 2 → PNP
0x4D	0	R/W	Function digital output 2		Configure digital output	1	0 → Output open 1 → Output close 2 → Output error 3 → Output error & warning
0x4E	1	R/W	Logic digital inputs / outputs	Input 1	Configure logical digital input 1	0	0 → Active high 1 → Active low
	2	R/W		Input 2	Configure logical digital input 2	0	0 → Active high 1 → Active low
	3	R/W		Input / output 1	Configure logical digital input/output	0	0 → Active high 1 → Active low
	4	R/W		Output 2	Configure logical digital output	0	0 → Active high 1 → Active low

Index	Sub-Index	Access rights	Index name	Parameter	Function	Default settings	Setting options
0x4F	1	R/W	Error action	Error action	Set safety position	2	0 → Hold 1 → Open 2 → Close
	2	R/W		Error time	Determine time from error detection to error message	1 (0.1s)	1 ... 1000 (0.1s ... 100s)
0x50	1	R/W	Basic settings	Inversion of LED colours	Activate / deactivate inversion of LEDs	0	0 → Standard 1 → Inversed
	2	R/W		On site initialization	Activate / deactivate on site initialization	0	0 → Enabled 1 → Disabled
	3	R/W		Operating mode	Operating mode change-over (positioner; ON/OFF)	0	0 → Positioner 1 → On/Off
	4	R/W		IO-Link process data	Activate/deactivate use of IO-Link process data	0	0 → Disabled 1 → Enabled
0x51	1	R/W	Actuator position feedback	Open request	Request valve position OPEN	900 (90.0%)	30 ... 970 (3.0 ... 97.0%)
	2	R/W		Close request	Request valve position CLOSED	100 (10.0%)	30 ... 970 (3.0 ... 97.0%)
	3	RO		Open real	Real valve position OPEN		0 ... 4095
	4	RO		Close real	Real valve position CLOSED		0 ... 4095
0x53	1	RO	Initialized positions	Open	Analog value valve position OPEN		0 ... 4095
	2	RO		Close	Analog value valve position CLOSED		0 ... 4095
	3	RO		Stroke	Read out the analog value for stroke (difference between OPEN and CLOSED).		0 ... 4095
0x55	1	RO	Calibrated positions	Max.	OPEN end position		0 ... 4095
	2	RO		Min.	CLOSED end position		0 ... 4095
0x60	1	RO	Analog values	Potentiometer	Analog value potentiometer		0 ... 4095
	2	RO		Supply voltage	Analog value supply voltage		0 ... 4095
	3	RO		Temperature	Analog value temperature sensor		0 ... 4095
	4	RO		Set value (W)	Analog value set value signal		0 ... 4095
0x62	1	RO	Operating times	Open	Operating time OPEN	0	0 to 255 (0 to 25.5s)
	2	RO		Close	Operating time CLOSE	0	0 to 255 (0 to 25.5s)
0x90	2	R/W	Drive sets	Force	Force, dependent on valve used		1 ... 6

Index	Sub-Index	Access rights	Index name	Parameter	Function	Default settings	Setting options
	3	R/W		Force initialization	Force during initialization, dependent on valve used		1 ... 6
0xB0	1	R/W	Control parameters	P amplification	P component – positioner	200	1 ... 200 (0.1 ... 20.0)
	2	R/W		D amplification	D component – positioner	10	1 ... 200 (0.1 ... 20.0)
	3	R/W		Derivative time	Delay constant	0	0 to 100 (0 to 100 s)
	4	R/W		Dead band	Permissible system deviation	10	1 ... 250 (0.1 ... 25.0 %)
0xB2	1	R/W	Open / close tight	Open tight	Sealing function valve position OPEN	995	800 ... 1000 (80.0 ... 100.0 %)
	2	R/W		Close tight	Sealing function valve position CLOSED	5	0 ... 200 (0 ... 20.0 %)
0xB4	1	R/W	Split range	Split start	Set set value start	0	0 to Split End – 100 (0.0 to Split End – 10.0%)
	2	R/W		Split end	Set set value end	1000	Split Start + 100 to 1000 (Split Start + 10.0% to 100.0%)
0xB6	1	R/W	Stroke limiter	Max pos	Stroke limiter valve position OPEN	1000	Min Pos to 1000 (Min Pos to 100.0%)
	2	R/W		Min pos	Stroke limiter valve position CLOSED	0	0 to Max Pos (0.0% to Max Pos)
0xB8	1	R/W	Set value (W) input	Direction	Set value direction set value input	0	0 → Rise (rising) 1 → Fall (falling)
	2	R/W		Type	Determine signal input	1	0 → 0 to 20 mA 1 → 4 to 20 mA 2 → 0 to 10 V
	3	R/W		I min	Determine minimum current input	35	0 to 40 (0 to 4.0 mA)
	4	R/W		I max	Determine maximum current input	205	200 to 220 (20.0 to 22.0 mA)
	5	R/W		U max	Determine maximum current input	103	100 to 110 (10.0 to 11.0 V)
0xBA	1	R/W	Analog output	Direction	Set value direction set value output	0	0 → Rise (rising) 1 → Fall (falling)
	2	R/W		Type	Determine signal output	1	0 → 0 to 20 mA 1 → 4 to 20 mA 2 → 0 to 10 V
	3	R/W		Min.	Determine minimum signal output	0	0 to Max (0.0% to Max)
	4	R/W		Max	Determine maximum signal output	1000	Min to 1000 (Min to 100%)

12.4 Parameter

The motorized linear actuator eSyStep supports parameter data in the ISDU (Index Service Data Unit). Parameters can be transmitted non-cyclically with ISDU. Block parametrization and data storage are also supported.

12.4.1 System command

The commands required for block parametrization and data storage are transmitted with the **System command** parameter.

Index	Sub-Index	Off-set	Access Rights	Length	Index name	Parameter	Type	Values
0x02	0	0	W	1 byte	System command		UIntegerT	0x01 to 0x06 0x82

Description of parameter values

Index name	Parameter	Values	Description
System command		0x01 to 0x06	Access to IO-Link
		0x82	Reset product to default settings *

* Except the index 0x90 settings – Drive Sets, these are not reset.

12.4.2 Data storage index

Changes to the parameters are stored in the IO-Link master with the **Data storage index** parameter and restored with a IO-Link device identical in construction when replaced. To do so, the **Data storage** parameter must be enabled in the Device access locks (see Chapter 12.4.3, page 47) parameter. The parameters are automatically replaced via the IO-Link master.

Index	Sub-Index	Off-set	Access Rights	Length	Index name	Parameter	Type	Values
0x03	1	0	R/W	1 byte	Data storage index	Data Storage Cmd	UIntegerT8	
	2	8	RO	1 byte		State Property	UIntegerT8	
	3	16	RO	4 bytes		Data Storage Size	UIntegerT32	
	4	48	RO	4 bytes		Parameter Check-sum	UIntegerT32	
	5	80	RO	41 bytes		Index List	OctetStringT	

12.4.3 Device access locks

Access to the parameters can be controlled with the **Device access locks** parameter.

Index	Sub-Index	Off-set	Access Rights	Length	Index name	Parameter	Type	Values
0x0C	1	0	R/W	1 bit	Device access locks	Parameter (write) access	BooleanT	0
								1
	2	1	R/W	1 bit		Data storage	BooleanT	0
								1
	3	2	R/W	1 bit		Local parameterization	BooleanT	0
								1
	4	3	R/W	1 bit		Local user interface	BooleanT	0
								1

Description of parameter values

Index name	Parameter	Values	Description
Device access locks	Local user interface	0	Enable write access
		1	Block write access
	Data storage	0	Enable storage of parameter data in the IO-Link master
		1	Block storage of parameter data in the IO-Link master
	Local parameterization	0	Enable local parameterization
		1	Block local parameterization
	Local user interface	0	Enable local user interface
		1	Block local user interface

12.4.4 Profile Characteristics

The **Profile Characteristics** parameter specifies which DeviceProfileIDs, CommonApplicationProfileIDs and FunctionClassIDs are supported.

Index	Sub-Index	Off-set	Access Rights	Length	Index name	Parameter	Type	Values
0x0D	0	0	RO	8 bytes	Profile Characteristics		ArrayT	0x8000
								0x8002
								0x8003
								0x8100

Description of parameter values

Index name	Parameter	Values	Description
Profile Characteristics		0x8000	Device identification objects
		0x8002	Process data mapping
		0x8003	Diagnostics
		0x8100	External identification

12.4.5 ProcessData Input Descriptor

The **ProcessData Input Descriptor** parameter describes the data format of the process data. Thus the master receives information about the process data without IODD.

Index	Sub-Index	Off-set	Access Rights	Length	Index name	Parameter	Type	Values
0x0E	0	0	RO	3 byte	ProcessData Input Descriptor		ArrayT	0x00
								0x03
								0x01

Description of parameter values

Index name	Parameter	Values	Description
ProcessData Input Descriptor		0x00	Bit offset
		0x03	Type length
		0x01	Data type -> BoolT

12.4.6 ProcessData Output Descriptor

The **ProcessData Output Descriptor** parameter describes the data format of the process data. Thus the master receives information about the process data without IODD.

Index	Sub-Index	Off-set	Access Rights	Length	Index name	Parameter	Type	Values
0x0F	0	0	RO	3 byte	ProcessData Output Descriptor		ArrayT	0x00
								0x04
								0x01

Description of parameter values

Index name	Parameter	Values	Description
ProcessData Output Descriptor		0x00	Bit offset
		0x04	Type length
		0x01	Data type -> BoolT

12.4.7 Vendor name

The manufacturer name can be read out in ASCII format with the **Vendor name** parameter.

Index	Sub-Index	Off-set	Access Rights	Length	Index name	Parameter	Type	Values
0x10	0	0	RO	5 bytes	Vendor name		StringT	"GEMUE"

12.4.8 Product name

The device name can be read out in ASCII format with the **Product name** parameter.

Index	Sub-Index	Off-set	Access Rights	Length	Index name	Parameter	Type	Values
0x12	0	0	RO	18 byte	Product name		StringT	"eSyStep Positioner"

12.4.9 Product ID

The product ID can be read out in ASCII format with the **Product ID** parameter.

Index	Sub-Index	Off-set	Access Rights	Length	Index name	Parameter	Type	Values
0x13	0	0	RO	18 byte	Product ID		StringT	"eSyStep Positioner"

12.4.10 Serial number

The serial number of the device can be read out with the **Serial number** parameter.

The serial number consists of an 8-digit traceability number, a forward slash and a 4-digit index.

Index	Sub-Index	Off-set	Access Rights	Length	Index name	Parameter	Type	Values
0x15	0	0	RO	13 bytes	Serial number		StringT	"XXXXXXXX/YYYY"

12.4.11 Hardware revision

The circuit boards' version can be read out with the **Hardware revision** parameter.

The hardware version is displayed with the 2-digit version number of the basic assembly and the 2-digit version number of the OPEN/CLOSED or positioner assembly.

Index	Sub-Index	Off-set	Access Rights	Length	Index name	Parameter	Type	Values
0x16	0	0	RO	10 bytes	Hardware revision		StringT	"Rev. XX/XX"

12.4.12 Firmware revision

The software version can be read out with the **Firmware revision** parameter.

Index	Sub-Index	Off-set	Access Rights	Length	Index name	Parameter	Type	Values
0x17	0	0	RO	21 byte	Firmware revision		StringT	"V X.X.X.X"

12.4.13 Application specific tag

A text with 32 characters can be stored in the device with the **Application specific tag** parameter.

For example, installation location, function, installation date, etc.

Index	Sub-Index	Off-set	Access Rights	Length	Index name	Parameter	Type	Values
0x18	0	0	R/W	32 bytes	Application specific tag		StringT	„***** " "

12.4.14 Function tag

A text with 32 characters can be stored in the device with the **Function tag** parameter.

For example, installation location, function, installation date, etc.

Index	Sub-Index	Off-set	Access Rights	Length	Index name	Parameter	Type	Values
0x19	0	0	R/W	32 bytes	Function tag		StringT	„*****“

12.4.15 Location tag

A text with 32 characters can be stored in the device with the **Location tag** parameter.

For example, installation location, function, installation date, etc.

Index	Sub-Index	Off-set	Access Rights	Length	Index name	Parameter	Type	Values
0x1A	0	0	R/W	32 bytes	Location tag		StringT	„*****“

12.4.16 Device Status

The simple device status can be read out with the **Device Status** parameter.

Index	Sub-Index	Off-set	Access Rights	Length	Index name	Parameter	Type	Values
0x24	0	0	RO	1 byte	Device Status		uint: 8	0 2 4

Description of parameter values

Index name	Parameter	Values	Description
Device Status		0	The valve is operating properly
		2	The valve is operated outside the specification
		4	The valve is in fault status

12.4.17 Detailed Device Status

The detailed device status can be read out with the **Detailed Device Status** parameter. The values of the array correspond to the IO-Link events (see chapter 12.5 Events).

Index	Sub-Index	Off-set	Access Rights	Length	Index name	Parameter	Type	Values
0x25	0	0	RO	39 byte	Detailed Device Status		ArrayT	See chapter 12.5 Events

Description of parameter values

Index name	Parameter	Values	Description
Detailed Device Status			See chapter 12.5 Events

12.4.18 Actuator size

The actuator size can be read out in numbers with the **Actuator size** parameter.

Index	Sub-Index	Offset	Access Rights	Length	Index name	Parameter	Type	Default	Values
0x40	0	0	RO	2 bits	Actuator size		uint: 8	Depending on the actuator size used	0 → size 0 1 → size 1 2 → size 2

12.4.19 Function digital inputs

The functions of the digital inputs can be configured with the **Function digital inputs** parameter.

Index	Sub-Index	Offset	Access Rights	Length	Index name	Parameter	Type	Default	Values
0x4B	1	0	R/W	3 bits	Function digital inputs	Input 1	uint:8	4	0
									1
									2
									3
									4
	2	8	R/W	3 bits		Input 2	uint:8	0	0
									1
									2
									3
									4

Description of parameter values

Index name	Parameter	Values	Description
Function digital inputs	Input 1	0	(Off) Input without function.
		1	(Open) In case of the corresponding signal, the actuator moves in the OPEN direction. If the other input (Digital Input 2) is configured as "Close", the actuator stops when the inputs are not actuated. If the other input is not configured as "Close", the actuator moves independently in the CLOSED direction when the "Open" input is not actuated.
		2	(Close) In case of the corresponding signal, the actuator moves in the CLOSED direction. If the other input (Digital Input 2) is configured as "Open", the actuator stops when the inputs are not actuated. If the other input is not configured as "Open", the actuator moves independently in the OPEN direction when the "Close" input is not actuated.
		3	(Safe / On) Safety position of the device is triggered. The device operates normally if the signal is active. If there is no signal, the device moves into the safety position. The safety position is defined by the parameter Error Action (index 0x4F (see "Error Action").
		4	(Init) Input can be used as an initialization input.
	Input 2	0	(Off) Input without function.
		1	(Open) In case of the corresponding signal, the actuator moves in the OPEN direction. If the other input (Digital Input 1) is configured as "Close", the actuator stops when the inputs are not actuated. If the other input is not configured as "Close", the actuator moves independently in the CLOSED direction when the "Open" input is not actuated.
		2	(Close) In case of the corresponding signal, the actuator moves in the CLOSED direction. If the other input (Digital Input 1) is configured as "Open", the actuator stops when the inputs are not actuated. If the other input is not configured as "Open", the actuator moves independently in the OPEN direction when the "Close" input is not actuated.
		3	(Safe/On) Safety position of the device is triggered. The device operates normally if the signal is active. If there is no signal, the device moves into the safety position. The safety position is defined by the parameter Error Action (index 0x4F (see "Error Action").
		4	(Init) Input can be used as an initialization input.

12.4.20 Function digital in- / output 1

The function of the input/output can be set with the **Function Digital In-/Output 1** (subindex 1) parameter.

Index	Sub-Index	Offset	Access Rights	Length	Index name	Parameter	Type	Default	Values
0x4C	1	0	R/W	3 bits	Function digital in- / output 1	In- / output 1	uint:8	2	0
									1
									2
									3
									4
	2	8	R/W	3 bits		Type in- / output 1	uint:8	0	0
									1
									2
									2

Description of parameter values

Index name	Parameter	Values	Description
Function digital in- / output 1	In- / output	0	(Output Open) Signal is output with the corresponding valve position. Detection of Open depends on the setting of the parameter Position Feedback (index 0x51 (see "Actuator position feedback", page 57)) and a correct initialization.
		1	(Output Close) Signal is output with the corresponding valve position. Detection of Close depends on the setting of the parameter Position Feedback (index 0x51 (see "Actuator position feedback", page 57)) and a correct initialization.
		2	(Output Error) Only output error detection.
		3	(Output Error & Warning) Output error and warnings.
		4	(Input Init) Configure input/output as initialization input.
	Type in- / output	0	(Push-Pull) Configure output as Push-Pull.
		1	(NPN) Configure output as NPN.
		2	(PNP) Configure output as PNP.

12.4.21 Function digital output 2

The output function can be set with the **Function digital output 2** parameter.

Index	Sub-Index	Offset	Access Rights	Length	Index name	Parameter	Type	Default	Values	
0x4D	0	0	R/W	2 bits	Function digital output 2		uint:8	2	0	
										1
										2
										3

Description of parameter values

Index name	Parameter	Values	Description
Function digital output		0	(Output Open) Signal is output with the corresponding valve position. Detection of Open depends on the setting of the parameter Position Feedback (index 0x51 (see "Actuator position feedback", page 57)) and a correct initialization.
		1	(Output Close) Signal is output with the corresponding valve position. Detection of Close depends on the setting of the parameter Position Feedback (index 0x51 (see "Actuator position feedback", page 57)) and a correct initialization.
		2	(Output Error) Only output error detection.
		3	(Output Error & Warning) Output error and warnings.

12.4.22 Logic digital inputs / outputs

The inputs and outputs can be inverted with the **Logic digital inputs/outputs** parameters.

Index	Sub-Index	Offset	Access Rights	Length	Index name	Parameter	Type	Default	Values
0x4E	1	0	R/W	1 bit	Logic digital inputs / outputs	Input 1	Boolean	0	0
									1
	2	1	R/W	1 bit		Input 2	Boolean	0	0
									1
	3	2	R/W	1 bit		Input / output 1	Boolean	0	0
									1
	4	3	R/W	1 bit		Output 2	Boolean	0	0
									1

Description of parameter values

Index name	Parameter	Values	Description
Logic digital inputs / outputs	Input 1	0	(Active high) Input 1 not inverted.
		1	(Active low) Input 1 inverted.
	Input 2	0	(Active high) Input 2 not inverted.
		1	(Active low) Input 2 inverted.
	Input / output 1	0	(Active high) Input/output not inverted.
		1	(Active low) Input/output inverted.
	Output 2	0	(Active high) Output not inverted.
		1	(Active low) Output inverted.

12.4.23 Error action

The safety position can be set with the **Error action** parameter.

The safety position is approached when an error occurs, if the supply voltage is too low within the range of 17.8 V to 21.1 V or in case of the corresponding signal present at Safe/On.

NOTICE

- ▶ Except the Temperature Over-Run error device, exceeding the permissible motor temperature. If the permissible temperature is exceeded, the motor is switched off to prevent damage.

Index	Sub-Index	Off-set	Access Rights	Length	Index name	Parameter	Type	Default	Values
0x4F	1	0	R/W	2 bits	Error action	Error action	uint:8	2	0
									1
	2	0	R/W	10 bits		Error time	uint:16	1 (0.1s)	1 ... 1000 (0.1s to 100s)

Description of parameter values

Index name	Parameter	Values	Description
Error action	Error action	0	(Hold) Actuator remains in the current position in case of an error.
		1	(Open) Actuator moves to the OPEN position in case of an error.
		2	(Close) Actuator moves to the CLOSED position in case of an error.
	Error time	1 ... 1000	Determine delay time between error detection and error message.

12.4.24 Basic settings

The different settings are summarized with the **Basic settings** parameter.

Index	Sub-Index	Offset	Access Rights	Length	Index name	Parameter	Type	Default	Values
0x50	1	0	R/W	1 bit	Basic settings	Inversion of LED colours	Boolean	0	0
									1
	2	1	R/W	1 bit		On site initialization	Boolean	0	0
									1
	3	2	R/W	1 bit		Operating mode	Boolean	0	0
									1
	4	3	R/W	1 bit		IO-Link process data	Boolean	0	0
									1

Description of parameter values

Index name	Parameter	Values	Description
Basic settings	Inversion of LED colours	0	(Standard) LEDs Close = green and Open = yellow (not inverted).
		1	(Inversed) LEDs Close = yellow and Open = green (inversed).
	On site initialization	0	(Enabled) On-site initialization (see "Initialization", page 65) activated.
		1	(Disabled) On-site initialization (see "Initialization", page 65) deactivated.
	Operating mode	0	Operating mode for positioner activated.
		1	Operating mode for OPEN/CLOSE control activated.
	IO-Link process data	0	(Disabled) Use of IO-Link process data (see "Process data", page 41) is deactivated.
		1	(Enabled) Use of IO-Link process data (see "Process data", page 41) is activated.

12.4.25 Actuator position feedback

The settings for the OPEN and CLOSED position feedback can be stored with the **Actuator position feedback** parameter.

Index	Sub-Index	Offset	Access Rights	Length	Index name	Parameter	Type	Default	Values
0x51	1	0	R/W	10 bits	Actuator position feedback	Open request	uint:16	900 (90.0%)	30 ... 970 (3.0 ... 97.0%)
	2	16	R/W	10 bits		Close request	uint:16	100 (10.0%)	30 ... 970 (3.0 ... 97.0%)
	3	32	RO	10 bits		Open real	uint:16		0 ... 4095
	4	48	RO	10 bits		Close real	uint:16		0 ... 4095

Description of parameter values

Index name	Parameter	Values	Description
Actuator position feedback	Open request	30 ... 970 (3.0 ... 97.0%)	Request valve position OPEN
	Close request	30 ... 970 (3.0 ... 97.0%)	Request valve position CLOSED
	Open real	0 ... 4095	Real valve position OPEN
	Close real	0 ... 4095	Real valve position CLOSED

12.4.26 Initialized positions

The analog values of the initialized valve positions can be read out with the **Initialized positions** parameter.

Index	Sub-Index	Offset	Access Rights	Length	Index name	Parameter	Type	Default	Values
0x53	1	0	RO	12 bits	Initialized positions	Open	uint:16	0	0 ... 4092
	2	16	RO	12 bits		Close	uint:16	4092	0 ... 4092
	3	32	RO	12 bits		Stroke	uint:16	0	0 ... 4092

Description of parameter values

Index name	Parameter	Values	Description
Initialized positions	Open	0 ... 4092	Analog value valve position OPEN
	Close	0 ... 4092	Analog value valve position CLOSED
	Stroke	0 ... 4092	Analog value stroke (difference between OPEN and CLOSED).

12.4.27 Calibration positions

The values of the factory calibration can be read out with the **Calibration positions** parameter.

The values are analog values of the potentiometer in the mechanical end positions of the actuator.

Index	Sub-Index	Offset	Access Rights	Length	Index name	Parameter	Type	Default	Values
0x55	1	0	RO	12 bits	Calibration positions	Max.	uint:16	0	0 ... 4092
	2	16	RO	12 bits		Min.	uint:16	4092	0 ... 4092

Description of parameter values

Index name	Parameter	Values	Description
Calibration positions	Max.	0 ... 4092	Read out analog value of the potentiometer for the mechanical end position OPEN.
	Min.	0 ... 4092	Read out analog value of the potentiometer for the mechanical end position CLOSED.

12.4.28 Analog values

Different analog values can be read out with the **Analog values** parameter.

Index	Sub-Index	Offset	Access Rights	Length	Index name	Parameter	Type	Values
0x60	1	0	RO	12 bits	Analog values	Potentiometer	uint:16	0 ... 4095
	2	16	RO	12 bits		Supply voltage	uint:16	0 ... 4095
	3	32	RO	12 bits		Temperature	uint:16	0 ... 4095
	4	48	RO	12 bits		Set value (W)	uint:16	0 ... 4095

Description of parameter values

Index name	Parameter	Values	Description
Analog values	Potentiometer	0 ... 4095	Read out current analog value of the potentiometer.
	Supply voltage	0 ... 4095	Read out current analog value of the supply voltage.
	Temperature	0 ... 4095	Read out current analog value of the temperature sensor.
	Set value (W)	0 ... 4095	Read out current analog value of the set value.

12.4.29 Operating times

The current valve travel times can be read out with the **Operating times** parameter.

Index	Sub-Index	Offset	Access Rights	Length	Index name	Parameter	Type	Default	Values
0x62	1	0	RO	8 bits	Operating times	Open	uint:8	0	0 to 255, 0 to 25.5 s
	2	8	RO	8 bits		Close	uint:8	0	0 to 255, 0 to 25.5 s

Description of parameter values

Index name	Parameter	Values	Description
Operating times	Open	0 to 255 0 to 25.5 s	Read out operating time (in tenths of seconds) from end position CLOSED to end position OPEN.
	Close	0 to 255 0 to 25.5 s	Read out operating time (in tenths of seconds) from end position OPEN to end position CLOSED.

12.4.30 Drive sets

The force of the actuator can be influenced with the **Drive sets** parameter when the valve is initialized and during initialization.

Index	Sub-Index	Offset	Access Rights	Length	Index name	Parameter	Type	Default	Values
0x90	2	8	R/W	3 bits	Drive sets	Force	uint:16	-	1 ... 6
	3	16	R/W	3 bits		Force initialization	uint:16	-	1 ... 6

Description of parameter values

Index name	Parameter	Values	Description
Drive sets	Force	1 ... 6	Set the force of the valve. Preset at the factory depending on the valve type.
	Force initialization	1 ... 6	Set the force during initialization. Preset at the factory depending on the valve type.

Force settings

Actuator size	Setting parameter	Force
AG0 and AG1	1	Minimum force
	6	Maximum force

12.4.31 Control parameters

The properties can be set with the **Control parameters** parameter.

Index	Sub-Index	Offset	Access Rights	Length	Index name	Parameter	Type	Default	Values
0xB0	1	0	R/W	16 bits	Control parameters	P amplification	uint: 16	200	1 ... 200 (0.1 ... 20.0)
	2	16	R/W	16 bits		D amplification	uint: 16	10	1 ... 200 (0.1 ... 20.0)
	3	32	R/W	16 bits		Derivative time	uint: 16	0	0 to 100 (0 to 100 s)
	4	48	R/W	16 bits		Dead band	uint: 16	10	1 ... 250 (0.1 ... 25.0 %)

Description of parameter values

Index name	Parameter	Values	Description
Control parameters	P amplification	1 ... 200 (0.1 ... 20.0)	Set the P component of the positioner.
	D amplification	1 ... 200 (0.1 ... 20.0)	Set the D component of the positioner.
	Derivative time	0 to 100 (0 to 100 s)	Set the delay constant of the positioner.
	Dead band	1 ... 250 (0.1 ... 25.0 %)	Set the permissible system deviation of the positioner.

12.4.32 Open / close tight

The sealing function can be set for the **Open / close tight** parameter.

Index	Sub-Index	Offset	Access Rights	Length	Index name	Parameter	Type	Default	Values
0xB2	1	0	R/W	16 bits	Open / close tight	Open tight	uint:16	995	800 ... 1000 (80.0 ... 100.0 %)
	2	16	R/W	16 bits		Close tight	uint:16	5	0 ... 200 (0.0 ... 20.0 %)

Description of parameter values

Index name	Parameter	Values	Description
Open / close tight	Open tight	800 ... 1000 (80.0 ... 100.0 %)	Set the sealing function valve position OPEN.
	Close tight	0 ... 200 (0 ... 20.0 %)	Set the sealing function valve position CLOSED.

12.4.33 Split range

The start and end of the set value range can be set for **Split range** parameter.

Index	Sub-Index	Off-set	Access Rights	Length	Index name	Parameter	Type	Default	Values
0xB4	1	0	R/W	16 bits	Split range	Split start	uint: 16	0	0 to Split End – 100 (0.0 to Split End – 10.0%)
	2	16	R/W	16 bits		Split end	uint: 16	1000	Split Start + 100 to 1000 (Split Start + 10.0% to 100.0%)

Description of parameter values

Index name	Parameter	Values	Description
Split range	Split start	0 to Split End – 100 (0.0 to Split End – 10.0%)	Set the start of the set value range.
	Split end	Split Start + 100 to 1000 (Split Start + 10.0% to 100.0%)	Set the end of the set value range.

12.4.34 Stroke limiter

The upper and lower valve position of the control range can be set as stroke limiter with the **Stroke limiter** parameter.

NOTICE

To use the stroke limiter, the close tight function (open/close tight) must be deactivated. To do this, Open tight must be set to the value 1000 (100.0%) and Close tight to the value 0 (0.0%).

Index	Sub-Index	Off-set	Access Rights	Length	Index name	Parameter	Type	Default	Values
0xB6	1	0	R/W	16 bits	Stroke limiter	Max pos	uint:16	1000	Min Pos to 1000 (Min Pos to 100.0%)
	2	16	R/W	16 bits		Min pos	uint:16	0	0 to Max Pos (0.0% to Max Pos)

Description of parameter values

Index name	Parameter	Values	Description
Stroke limiter	Max pos	Min Pos to 1000 (Min Pos to 100.0%)	Set the stroke limiter of the control range in valve position OPEN.
	Min pos	0 to Max Pos (0.0% to Max Pos)	Set the stroke limiter of the control range in valve position CLOSED.

12.4.35 Set value (W) input

The function of the analog input can be set with the **Set value (W) input** parameter.

Index	Sub-Index	Offset	Access Rights	Length	Index name	Parameter	Type	Default	Values
0xB8	1	0	R/W	1 bit	Set value (W) input	Direction	uint:1	0	0 1
	2	8	R/W	2 bits		Type	uint:2	1	0 1 2
	3	16	R/W	8 bits		I min	uint:8	35	0 to 40 (0 to 4.0 mA)
	4	24	R/W	8 bits		I max	uint:8	205	200 to 220 (20.0 to 22.0 mA)
	5	32	R/W	8 bits		U max	uint:8	103	100 to 110 (10.0 to 11.0 V)

Description of parameter values

Index name	Parameter	Values	Description
Set value (W) input	Direction	0	Specify direction of the set value input. 0 = Rise (rising) 1 = Fall (falling)
		1	
	Type	0	Determine signal input. 0 = 0 to 20 mA 1 = 4 to 20 mA 2 = 0 to 10 V
		1	
		2	
I min	0 to 40 (0 to 4.0 mA)	Determine minimum value of the current input. If the set value is not reached, the message "Set value too small" is issued.	
I max	200 to 220 (20.0 to 22.0 mA)	Determine maximum value of the current input. If the set value is exceeded, the message "Set value too high" is issued.	
U max	100 to 110 (10.0 to 11.0 V)	Determine maximum value of the voltage input. If the set value is exceeded, the message "Set value too high" is issued.	

12.4.36 Analog output

The analog output function can be set with the **Analog Output** parameter.

Index	Sub-Index	Offset	Access Rights	Length	Index name	Parameter	Type	Default	Values
0xBA	1	0	R/W	1 bit	Analog output	Direction	Boolean	0	0 1
	2	8	R/W	2 bits		Type	uint:8	1	0 1 2
	3	16	R/W	16 bits		Min.	uint:16	0	0 to Max (0.0% to Max)
	4	32	R/W	16 bits		Max.	uint:16	1000	Min to 1000 (Min to 100%)

Description of parameter values

Index name	Parameter	Values	Description
Analog output	Direction	0	Specify direction of the set value output. 0 = Rise (rising) 1 = Fall (falling)
		1	
	Type	0	Determine signal output. 0 = 0 to 20 mA 1 = 4 to 20 mA 2 = 0 to 10 V
		1	
2			
Min.	0 to Max (0.0% to Max)	Determine minimum value of the output.	
Max.	Min to 1000 (Min to 100%)	Determine maximum value of the output.	

12.5 Events

The following IO-Link events can be transmitted.

Event	Mode	Type	Code
Device Hardware Fault	App/Disapp	Error	0x5000
Motor Unable To Move	App/Disapp	Error	0x8CE0
Device Temperature Over-Run	App/Disapp	Warning/Error	0x4210
Emergency Power	App/Disapp	Warning	0x5100
Primary Supply Voltage Under-Run	App/Disapp	Warning/Error	0x5111
Potifail Close	App/Disapp	Warning	0x8CA5
Potifail Open	App/Disapp	Warning	0x8CA4

Description – Events

Event	Description	Possible cause	Troubleshooting
Device Hardware Fault 0x5000	The event occurs when a hardware fault is detected.	Fault in valve position detection. Parameter can no longer be read when switching the device on.	Contact GEMÜ Support
Motor Unable To Move 0x8CE0	The event occurs when the motor is blocked.	Valve is blocked (for example, solid stuck in valve). Valve corroded (rusted in place).	Check valve Carry out initialization if valve is OK

Event	Description	Possible cause	Troubleshooting
		End position can no longer be reached (after replacing the diaphragm).	
Device Temperature Over-Run 0x4210	The event occurs as a warning or error if the motor temperature is too high.	Control is operated outside of the specification. The ambient temperature is too high.	Check temperature Set control correctly (check duty cycle (ED) of the actuator)
Emergency Power 0x5100	The event occurs if the Safe/ On function is selected on a digital input and the enabling signal falls. For example, by triggering a fail safe function or in case of emergency power.	The connected external fail safe function triggers. Supply by an external emergency power supply module	Check the plant and search for the cause of the disconnection.
Primary Supply Voltage Under-Run 0x5111	The event occurs if the supply is too low. The event is triggered as a warning if the supply voltage U_v is below a value of 21.1 V. (If the supply voltage is below 17.4 V, the event Primary Supply Voltage Under-Run (0x5111) is triggered as an error).	Power supply unit overloaded. Cross-section of the supply line is too small. Supply line is too long.	Check supply
Potifail Close 0x8CA5	The event occurs if a valve position is read which can never be achieved in the "Close" direction.	Fault in valve position detection. Error when replacing a diaphragm (stroke of the valve in incorrect area). Actuator has been fitted on the valve incorrectly (stroke of the valve in the incorrect area).	Check valve/diaphragm
Potifail Open 0x8CA4	The event occurs if a valve position is read which can never be achieved in the "Open" direction.	Fault in valve position detection. Error when replacing a diaphragm (stroke of the valve in incorrect area). Actuator has been fitted on the valve incorrectly (stroke of the valve in the incorrect area).	Check valve/diaphragm

13 Operation

13.1 Initialization

NOTICE

- Initialisation should be carried out in a depressurised state, initialisation force = 1/2 nominal force. When initialising under operating pressure, the initialisation force (IO-Link Index 0x90 - Subindex 3 - Force initialization) must be adjusted.

Initialisation must be carried out under the following situations:

- Subsequent mounting of the position transmitter
- Disassembly or replacement of the drive
- Replacing the sealing elements

If the process valve is completely assembled at the factory, initialisation has already been carried out.

Initialisation can be carried out using the following procedures:

- Initialisation on site
- Initialisation via IO-Link
- Initialisation via configurable digital input (digital input must be set to "Init")

13.1.1 On-site initialization of the end positions

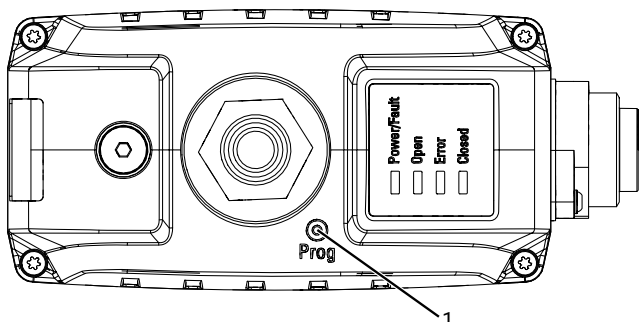

1. Connect supply voltage.
2. Hold the magnet briefly (>100 ms) at the point on the housing cover marked with PROG 1.
 - ⇒ OPEN and CLOSED LEDs flash alternately.
3. Valve automatically moves into the OPEN position.
4. Valve automatically moves into the CLOSED position.
5. Initialization mode is automatically ended.
6. The end positions are set.

13.1.2 Initialization of the end positions via IO-Link

1. Briefly activate (>100 ms) initialization mode (process data "Selection of operating mode").
 - ⇒ OPEN and CLOSED LEDs flash alternately.
2. Valve automatically moves into the OPEN position.
3. Valve automatically moves into the CLOSED position.
4. Initialization mode is automatically ended.
5. The end positions are set.

13.2 Manual override

Open, actuate and close the manual override with the hexagon socket (SW3).

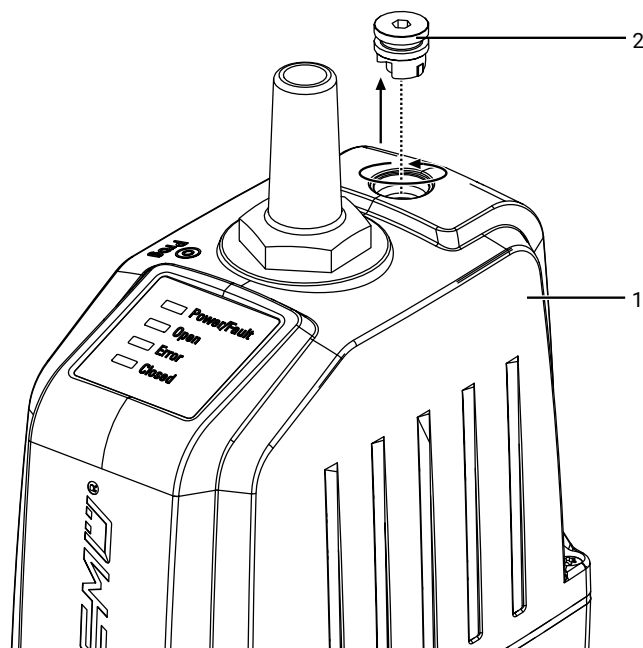

1. Unscrew sealing plug 2 anti-clockwise out of cover 1 and remove it.

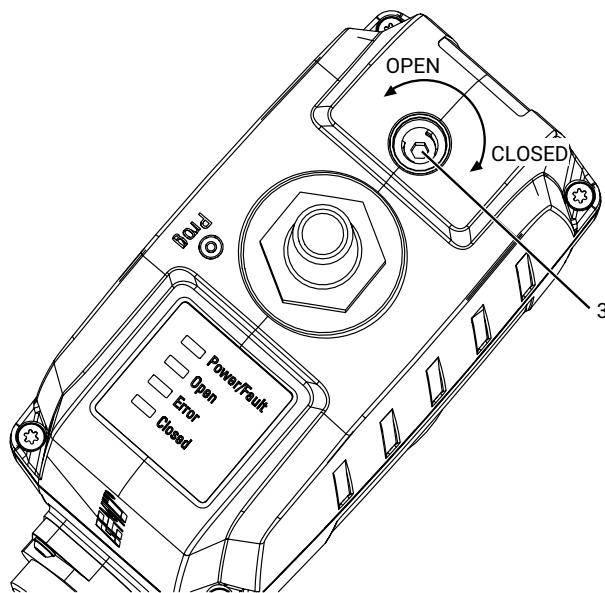

2. Operate the manual override 3 with the hexagon socket (WAF3).
 - ⇒ Turn clockwise to close the valve.
 - ⇒ Turn anticlockwise to open the valve.

14 Inspection and maintenance

⚠ WARNING



The equipment is subject to pressure!

- ▶ Risk of severe injury or death!
- Depressurize the plant or plant component.
- Completely drain the plant or plant component.

⚠ CAUTION

Use of incorrect spare parts!

- ▶ Damage to the GEMÜ product
- ▶ Manufacturer liability and guarantee will be void.
- Use only genuine parts from GEMÜ.

⚠ CAUTION



Hot plant components!

- ▶ Risk of burns
- Only work on plant that has cooled down.

NOTICE

Exceptional maintenance work!

- ▶ Damage to the GEMÜ product
- Any maintenance work and repairs not described in these operating instructions must not be performed without consulting the manufacturer first.

The operator must carry out regular visual examination of the GEMÜ products dependent on the operating conditions and the potential danger in order to prevent leakage and damage.

The product also must be disassembled and checked for wear in the corresponding intervals.

1. Have servicing and maintenance work performed by trained personnel.
2. Wear appropriate protective gear as specified in plant operator's guidelines.
3. Shut off plant or plant component.
4. Secure the plant or plant component against recommissioning.
5. Depressurize the plant or plant component.
6. Actuate GEMÜ products which are always in the same position four times a year.
7. If necessary, the end position counter **User** can be reset after maintenance or other changes under parameter Cycle Counter.

14.1 Spare parts

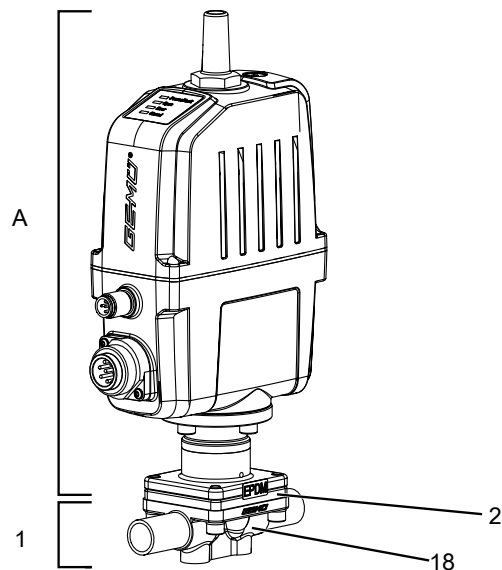

Item	Name	Order description
A	Actuator	9639...
1	Valve body	K600...
2	Diaphragm	600...M...
18	Bolt	639...S30...

14.2 Removing the actuator

1. Move the actuator **A** to the open position.
2. Loosen the fastening elements between actuator **A** and valve body **1** diagonally and remove them.
3. Lift actuator **A** off valve body **1**.
4. Move the actuator **A** to the closed position.
5. Clean all parts of contamination (do not damage parts during cleaning).
6. Check parts for potential damage, replace if necessary (only use genuine parts from GEMÜ).

14.3 Removing the diaphragm

1. Remove actuator **A** (see chapter "Removing the actuator").
2. Unscrew the diaphragm.
 - ⇒ Please note: Depending on the version, the compressor may fall out.
3. Clean all parts of contamination (do not damage parts during cleaning).
4. Check parts for potential damage, replace if necessary (only use genuine parts from GEMÜ).

14.4 Mounting the compressor

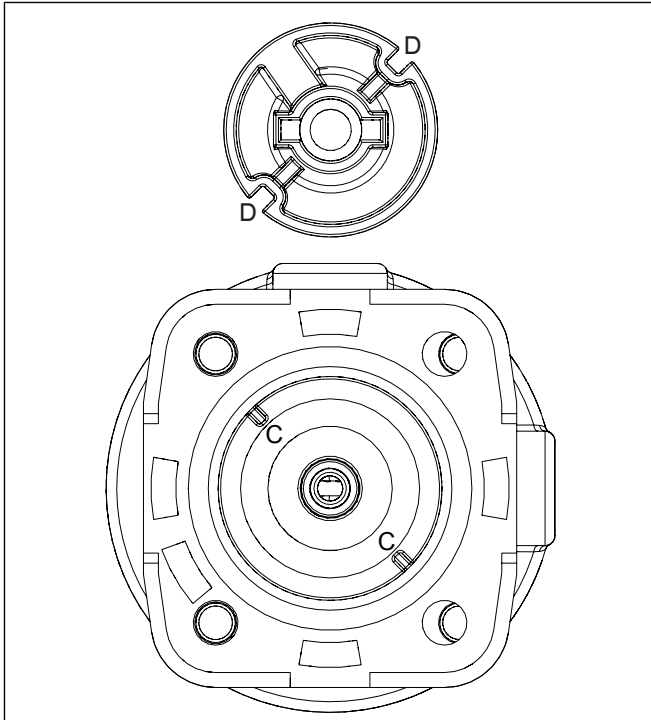
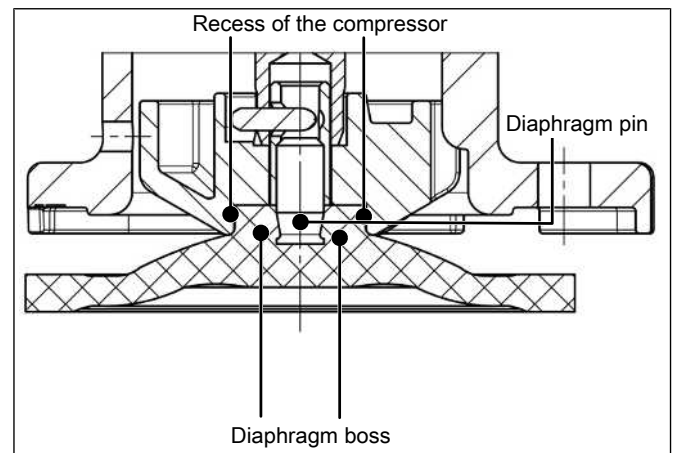

Fig. 5: Exemplary picture

1. Place the compressor loosely on the actuator spindle.
 2. Fit recesses **D** into guides **C**.
- ⇒ The compressor must be able to be moved freely between the guides.

14.5 Mounting the diaphragm

14.5.1 Mounting the concave diaphragm



1. Move the actuator **A** to the closed position.
2. Mount the compressor (see "Mounting the compressor").
3. Check if the compressor is fitted in the guides.
4. Manually screw new diaphragm tightly into the compressor.
5. Check if the diaphragm boss fits closely in the recess of the compressor.
6. If it is difficult to screw it in, check the thread and replace damaged parts.
7. When definitive resistance is felt, turn back the diaphragm until its bolt holes are in correct alignment with the bolt holes of the actuator.
8. Align the weir of compressor and diaphragm in parallel.

14.6 Mounting the actuator

NOTICE

Diaphragms set in the course of time.



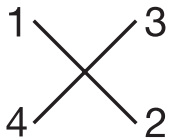





























































- ▶ Leakage
 - After disassembly/assembly of the product, check that the bolts and nuts on the body are tight and retighten if required.
 - Retighten the bolts and nuts at the very latest after the first sterilization process.
1. Move the actuator **A** to the open position.
 2. Place actuator **A** with the mounted diaphragm on valve body **1**.
 - ⇒ Take care that the diaphragm is in the correct orientation.
 3. Screw in bolts, washers and nuts hand tight.
 - ⇒ Fastening elements may vary depending on the diaphragm size and/or valve body version.
 4. Move the actuator **A** to the closed position.
 5. Open actuator **A** approx. 20%.
 6. Fully tighten the bolts with nuts diagonally.



7. Ensure even compression of the diaphragm (approx. 10 to 15%).
 - ⇒ Even compression is detected by an even outer bulge.
8. **Please note:** For a code 5M diaphragm (convex diaphragm), the PTFE diaphragm face and the EPDM backing diaphragm must be positioned level with and parallel to the valve body.
9. With the valve fully assembled, check the function and tightness.
10. Carry out initialisation.

15 Troubleshooting



15.1 LED error message

Function	Power/fault	Open	Error	Closed
Supply voltage too low				
	red			
Software Update				
Internal error				
Product not calibrated				
Motor does not move				
Product not initialized				
		Open and Closed flash alternately		
Temperature error				
Emergency power operation, OPEN position				
	red			
Emergency power operation, CLOSED position				
	red			
Emergency power operation, position unknown				
	red			
Set value too small				
Set value too high				
Abort IO-Link communication				
Maintenance required, OPEN position				
Maintenance required, CLOSED position				
Maintenance required, position unknown				

15.2 Troubleshooting

Error	Possible cause	Troubleshooting
The product is leaking downstream (does not close or does not close fully)	No initialization carried out after diaphragm replacement	Initialize the product
	Operating pressure too high	Operate the product with operating pressure specified in datasheet
	Foreign matter between shut-off diaphragm and valve body	Remove the actuator, remove foreign matter, check diaphragm and valve body for potential damage, replace damaged parts if necessary
	Shut-off diaphragm faulty	Check shut-off diaphragm for potential damage, replace the shut off diaphragm if necessary
The product is leaking in the passage (does not close or does not close completely).	Valve body leaking or damaged	Carry out initialisation, check valve body for damage, replace valve body if necessary.
The product does not open or does not open fully	No initialization carried out after diaphragm replacement	Initialize the product
	Actuator defective	Replace the actuator
	Shut-off diaphragm incorrectly mounted	Remove the actuator, check the diaphragm mounting, replace the shut-off diaphragm if necessary
	Operating pressure too high	Operate the product with operating pressure specified in datasheet
	Foreign matter in the product	Remove and clean the product
	The actuator design is not suitable for the operating conditions	Use an actuator that is designed for the operating conditions
	Voltage is not connected	Connect voltage
	Cable ends incorrectly wired	Wire cable ends correctly
The product does not close or does not close fully	The actuator design is not suitable for the operating conditions	Use an actuator that is designed for the operating conditions
	Foreign matter in the product	Remove and clean the product
	Voltage is not connected	Connect voltage
The product is leaking between actuator and valve body	Shut-off diaphragm incorrectly mounted	Remove the actuator, check the diaphragm mounting, replace the shut-off diaphragm if necessary
	Bolting between valve body and actuator loose	Tighten bolting between valve body and actuator
	Shut-off diaphragm faulty	Check shut-off diaphragm for potential damage, replace the shut-off diaphragm if necessary
	Actuator/valve body damaged	Replace actuator/valve body
The product is leaking between actuator flange and valve body	Mounting parts loose	Retighten mounting parts
	Valve body / actuator damaged	Replace valve body/actuator
Valve body of the GEMÜ product is leaking	Valve body of the GEMÜ product is faulty or corroded	Check valve body of the GEMÜ product for potential damage, replace valve body if necessary
Body of the GEMÜ product is leaking	Incorrect installation	Check installation of valve body in piping
Valve body connection to piping leaking	Incorrect installation	Check installation of valve body in piping

16 Removal from piping

 WARNING	
	<p>Corrosive chemicals!</p> <ul style="list-style-type: none"> ▶ Risk of caustic burns ● Wear appropriate protective gear. ● Completely drain the plant.

1. Remove in reverse order to installation.
2. Unscrew the electrical wiring.
3. Disassemble the product. Observe warning notes and safety information.

17 Disposal

1. Pay attention to adhered residual material and gas diffusion from penetrated media.
2. Dispose of all parts in accordance with the disposal regulations/environmental protection laws.

18 Returns

Legal regulations for the protection of the environment and personnel require that the completed and signed return delivery note is included with the dispatch documents. Returned goods can be processed only when this note is completed. If no return delivery note is included with the product, GEMÜ cannot process credits or repair work but will dispose of the goods at the operator's expense.

1. Clean the product.
2. Request a return delivery note from GEMÜ.
3. Complete the return delivery note.
4. Send the product with a completed return delivery note to GEMÜ.

19 EU Declaration of Incorporation according to the EC Machinery Directive 2006/42/EC, Annex II B



EU Declaration of Incorporation

according to the EC Machinery Directive 2006/42/EC, Annex II B

We, the company GEMÜ Gebr. Müller Apparatebau GmbH & Co. KG
Fritz-Müller-Strasse 6-8
74653 Ingelfingen-Criesbach, Germany

hereby declare under our sole responsibility that the below-mentioned product complies with the relevant essential health and safety requirements in accordance with Annex I of the above-mentioned Directive.

Product: GEMÜ 639
Product name: Motorized diaphragm valve
The following essential health and safety requirements of the EC Machinery Directive 2006/42/EC, Annex I have been applied or adhered to: 1.1.2.; 1.1.3.; 1.1.5.; 1.3.2.; 1.3.4.; 1.3.7.; 1.3.8.; 1.5.1.; 1.5.13.; 1.5.2.; 1.5.4.; 1.5.6.; 1.5.7.; 1.5.8.; 1.6.1.; 1.6.3.; 1.6.5.; 1.7.1.; 1.7.1.1.; 1.7.2.; 1.7.3.; 1.7.4.; 1.7.4.1.; 1.7.4.2.; 1.7.4.3.
The following harmonized standards (or parts thereof) have been applied: EN ISO 12100:2010

We also declare that the specific technical documents have been created in accordance with part B of Annex VII.

The manufacturer undertakes to transmit relevant technical documents on the partly completed machinery to the national authorities in response to a reasoned request. This communication takes place electronically.

This does not affect the industrial property rights.

The partly completed machinery may be commissioned only if it has been determined, if necessary, that the machinery into which the partly completed machinery is to be installed meets the provisions of the Machinery Directive 2006/42/EC.

M. Barghoorn
Head of Global Technics

Ingelfingen, 16/06/2023

GEMÜ Gebr. Müller Apparatebau GmbH & Co. KG
Fritz-Müller-Straße 6-8 D-74653 Ingelfingen-Criesbach

www.gemu-group.com
info@gemu.de

20 EU Declaration of Conformity in accordance with 2014/68/EU (Pressure Equipment Directive)



EU Declaration of Conformity

in accordance with 2014/68/EU (Pressure Equipment Directive)

We, the company GEMÜ Gebr. Müller Apparatebau GmbH & Co. KG
Fritz-Müller-Strasse 6-8
74653 Ingelfingen-Criesbach, Germany

hereby declare under our sole responsibility that the below-mentioned product complies with the regulations of the above-mentioned Directive.

Product: GEMÜ 639
Product name: Motorized diaphragm valve
Notified body: TÜV Rheinland Industrie Service GmbH
Am Grauen Stein 1
51105 Cologne, Germany

ID number of the notified body: 0035
No. of the QA certificate: 01 202 926/Q-02 0036
Conformity assessment procedure: Module H1

The following harmonized standards (or parts thereof) have been applied: EN 13397:2001

Information for products with a nominal size \leq DN 25:

The products are developed and produced according to GEMÜ's in-house process instructions and standards of quality which comply with the requirements of ISO 9001 and ISO 14001. According to Article 4, Paragraph 3 of the Pressure Equipment Directive 2014/68/EU, these products must not be identified by a CE-marking.

Other applied technical standards / Remarks:

- AD 2000

M. Barghoorn
Head of Global Technics
Ingelfingen, 16/06/2023

GEMÜ Gebr. Müller Apparatebau GmbH & Co. KG
Fritz-Müller-Straße 6-8 D-74653 Ingelfingen-Criesbach

www.gemu-group.com
info@gemu.de

21 EU Declaration of Conformity in accordance with 2014/30/EU (EMC Directive)



EU Declaration of Conformity
in accordance with 2014/30/EU (EMC Directive)

We, the company GEMÜ Gebr. Müller Apparatebau GmbH & Co. KG
Fritz-Müller-Strasse 6-8
74653 Ingelfingen-Criesbach, Germany

hereby declare under our sole responsibility that the below-mentioned product complies with the regulations of the above-mentioned Directive.

Product: GEMÜ 639
Product name: Motorized diaphragm valve
The following harmonized standards (or parts thereof) have been applied: EN 61000-6-4:2007/A1:2011; EN 61000-6-2:2005/AC:2005

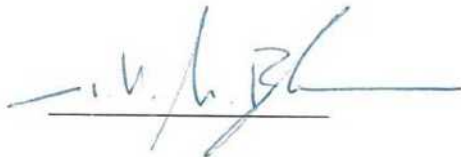

M. Barghoorn
Head of Global Technics
Ingelfingen, 16/06/2023

22 EU Declaration of Conformity In accordance with 2011/65/EU (RoHS Directive)



EU Declaration of Conformity
In accordance with 2011/65/EU (RoHS Directive)

We, the company GEMÜ Gebr. Müller Apparatebau GmbH & Co. KG
Fritz-Müller-Strasse 6-8
74653 Ingelfingen-Criesbach, Germany

hereby declare under our sole responsibility that the below-mentioned product complies with the regulations of the above-mentioned Directive.

Product: GEMÜ 639
Product name: Motorized diaphragm valve
The following harmonized standards (or parts thereof) have been applied: EN IEC 63000:2018

A handwritten signature in blue ink, appearing to read 'M. Barghoorn', is written over a horizontal line.

M. Barghoorn
Head of Global Technics
Ingelfingen, 16/06/2023



GEMÜ Gebr. Müller Apparatebau GmbH & Co. KG
Fritz-Müller-Straße 6-8, 74653 Ingelfingen-Criesbach, Germany
Phone +49 (0) 7940 1230 · info@gemue.de
www.gemu-group.com

Subject to alteration

06.2024 | 88668314